

RADIO-CRAFT

HUGO GERNSBACK, Editor

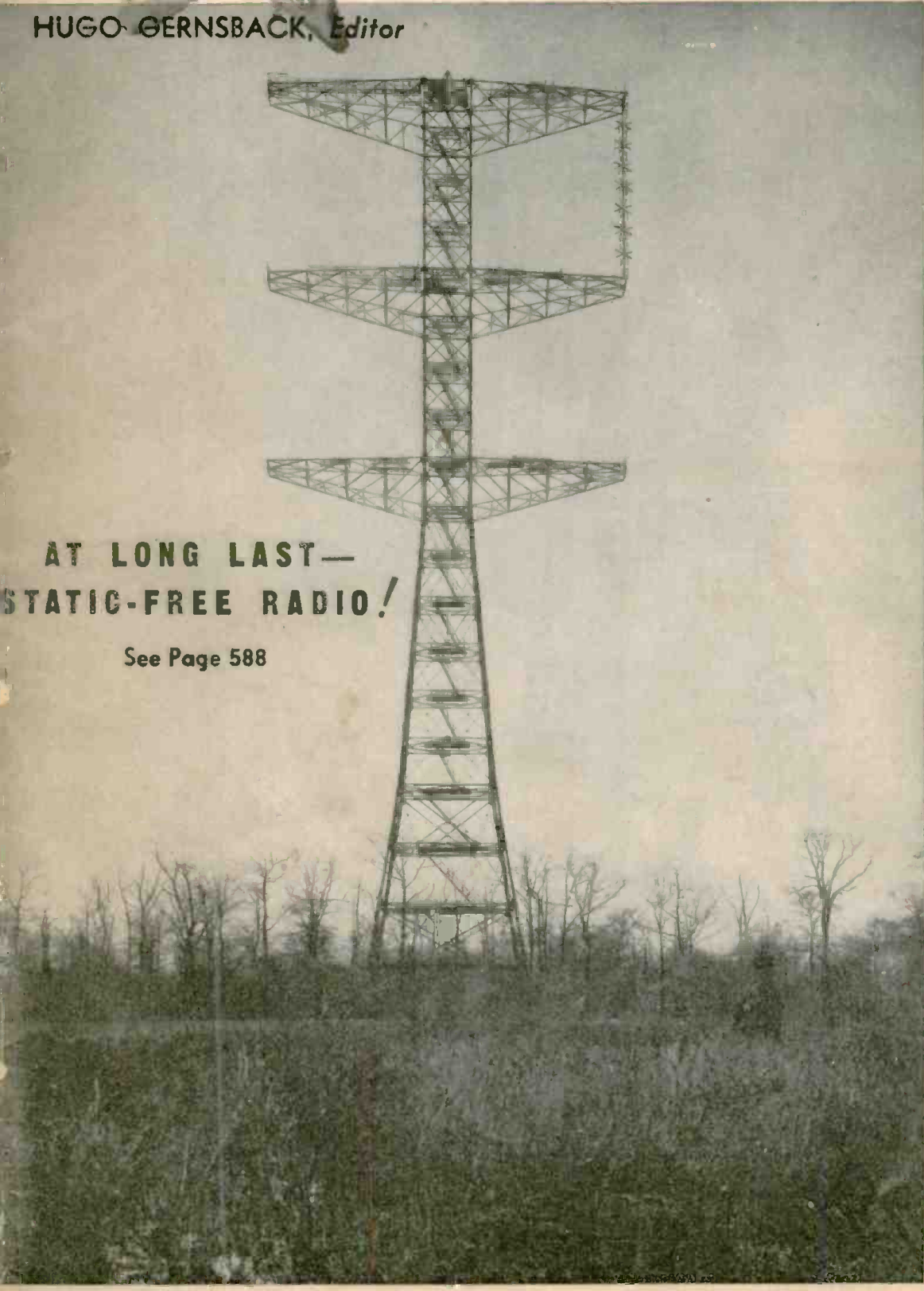

AT LONG LAST—
STATIC-FREE RADIO!

See Page 588



TRANSATLANTIC



TELEVISION



FACSIMILE

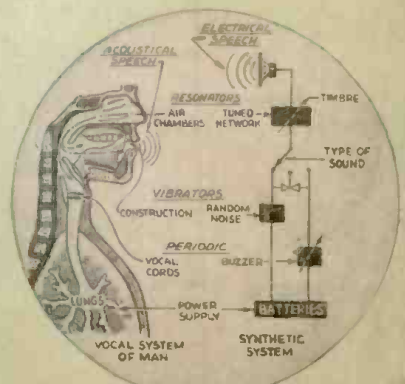

MANUFACTURED SPEECH

APRIL OVER 175 ILLUSTRATIONS
25c U.S. AND
"NOVACHORD" ELECTRO-MUSIC • A 3-TUBE SUPER. RECORDING AMPLIFIER • A.C. TO D.C. CONVERTER

RCA Introduces

New **WHITE
SCREEN**

**TELEVISION
TUBES**

906-P4—WHITE SCREEN... \$15.00

Introducing the new RCA-906-P4, a 3-inch television Kinescope. Similar to the present RCA-906 Cathode-Ray Tube, this new tube features a white fluorescent screen—and an unusually low cost! In addition to its low initial cost, this new tube provides low circuit cost because of its low voltage operation. Has conductive coating which minimizes deflecting-plate loading and prevents drifting of the pattern with changes in bias.

1802-P4—WHITE SCREEN... \$27.50

Introducing the 1802-P4, a 5-inch television Kinescope having electrostatic deflection and white screen. This tube provides excellent quality television pictures. *The deflection sensitivity is such that the beam may be deflected across the entire screen with no more voltage than is required for full deflection on 3-inch tube.* Separate terminals are provided in the new Magnal 11-pin base for each deflecting plate.

1802-P1—GREEN SCREEN... \$24.75

Introducing the 1802-P1, a new 5-inch oscillograph tube which is similar to the 1802-P4 except for its green screen. In oscillographic application the 1802-P1 represents extremely high quality because it is capable of providing excellent television pictures. For television purposes the 1802-P1 operates well with an anode potential of only 1200 volts.

RCA presents the Magic Key every Sunday, 2 to 3 P.M., E. S. T., on the NBC Blue Network

RCA Radio Tubes—first in metal, foremost in glass, finest in performance



for

TELEVISION

RCA Mfg. Co., Inc., Camden, N. J. A Service of the Radio Corporation of America



I jumped from \$18 a week to \$50
-- a Free Book started me toward this
GOOD PAY IN RADIO

HERE'S
How it
Happened
 by S. J. E.
 (NAME AND ADDRESS
 SENT UPON REQUEST)



"I had an \$18 a week job in a shoe factory. I'd probably be at it today if I hadn't read about the opportunities in Radio and started training at home for them."



"The training National Radio Institute gave me was so practical I was soon ready to make \$5, \$10, \$15 a week in spare time servicing radio sets."

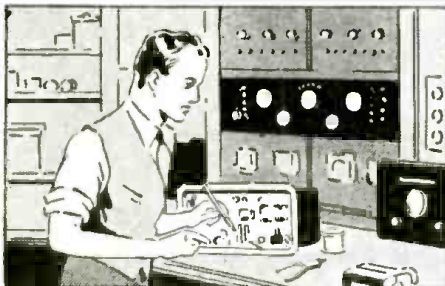

"When I finished training I accepted a job as serviceman with a Radio store. In three weeks I was made service manager at more than twice what I earned in the shoe factory."

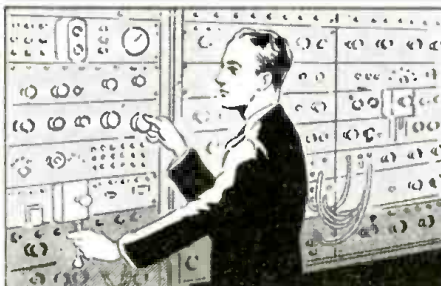

"Eight months later N. R. I. Employment Department sent me to Station KWCA as a Radio operator. Now I am Radio Engineer at Station WSUL I am also connected with Television Station W9XK."



"N. R. I. Training took me out of a low-pay shoe factory job and put me into Radio at good pay. Radio is growing fast. The field is wide open to properly trained men."



Find out today how I Train You at Home
to BE A RADIO EXPERT

Many Make \$30, \$50, \$75 a Week

Do you, too, want a better job? Do you, too, want to make more money? Radio offers many spare time and full time opportunities for good pay and more opportunities will come with Television.

Get Ready Now for Jobs Like These

Radio broadcasting stations employ engineers, operators, station managers and pay well for trained men. Fixing Radio sets in spare time pays many \$200 to \$500 a year—full time jobs with Radio jobbers, manufacturers and dealers, as much as \$30, \$50, \$75 a week. Many Radio Experts open full or part time radio sales and repair businesses. Radio manufacturers and jobbers employ testers, inspectors, foremen, engineers, servicemen, in good-pay jobs with opportunities for advancement. Automobile, police, aviation, commercial Radio and loud speaker systems are newer fields offering good opportunities now and for the future. Television promises to open many good jobs soon. Men I trained have good jobs in these branches of Radio. Read how they got their jobs. Mail coupon.

Many Make \$5, \$10, \$15 a Week Extra in Spare Time While Learning

The day you enroll I start sending you Extra Money Job Sheets. They show you how to do Radio repair jobs; how to cash in quickly. Throughout your training I send plans and ideas that made good spare time money—from \$200 to \$500 a year—for hundreds of fellows. I send special Radio equipment, give you practical Radio experience—show how to conduct experiments, build circuits

illustrating important Radio principles. I devote more than 19 Lesson Texts exclusively to Television methods and applications and cover Television fundamentals thoroughly in my Course.

I Also Give You This Professional Servicing Instrument

Here is the instrument every Radio expert needs and wants—an All-Wave, All-Purpose, Set Servicing Instrument. It contains everything necessary to measure A. C. and D. C. voltages and Current; to test tubes, resistance; adjust and align any set, old or new. It satisfies your needs for professional servicing after you graduate—can help you make extra money fixing sets while learning.



Find Out What Radio and Television Offer

Mail the coupon now for my Book, "Rich Rewards in Radio," and a sample lesson. They're free to any fellow over 16 years old. My book points out Radio's spare time and full time opportunities, also those coming in Television; tells about my Training in Radio and Television; shows you 131 letters from men I trained, shows what they are doing, earnings; shows my Money Back Agreement. MAIL COUPON in an envelope, or paste on penny post card—NOW!

J. E. SMITH,
 President
 National Radio Institute
 Dept. 9DX
 Washington, D. C.



**J. E. SMITH, President, National Radio Institute,
 Dept. 9DX, Washington, D. C.**

Dear Mr. Smith: Without obligation, send me free a Sample Lesson and your 64-page Book, "Rich Rewards in Radio," telling about spare time and full time Radio opportunities, and how I can train for them at home in spare time. (Please write plainly.)

Name Age

Address

City State 14x1

Please Say That You Saw It in RADIO-CRAFT

RADIO-CRAFT

HUGO GERNSBACK, *Editor-in-Chief*

N. H. LESSEM
Associate Editor

THOS. D. PENTZ
Art Director

ROBERT EICHBERG
Trade Digest Editor

R. D. WASHBURNE, *Managing Editor*

Contents APRIL, 1939 Issue

VOLUME X -- NUMBER 10

Editorial: \$150,118,450 Radio Time.....Hugo Gernsback	581
The Radio Month in Review.....	582
A Review—Radio Abroad in 1938.....	584
Manufactured Speech I.....	586
Radio Weather Station—I Mile Up!.....Walter A. Knoop	587
At Long Last—Static-Free Radiol.....	588
Announcing the "Novachord"—Electronic Music's New 163-Tube "Baby".....	589
A Modern Amplifier for Recording and Playback.....A. C. Shaney	590
This Home—"Wired for Radio"—Part III.....N. H. Lessem	592
The Pipeless OrganI—Part II.....Victor I. Zuck	594
An Easily-Built 3-Tube Midget Broadcast Superhet. Set....T. C. Elton	596
Complete Step-by-Step Dynamic Servicing—Part IV..Kendall Clough	598
New Circuits in Modern Radio Receivers—No. 19....F. L. Sprayberry	600
A Home-Made String-Music Pickup.....Kendall Ford	601
Simple Technique for Making Home Talkies—Part II.....C. A. Tuthill	602
Making a Shop-Type A.C. to D.C. Power Supply..George W. Halder	604
How the Beam-a-Scope Works!.....	605
The Latest Radio Equipment.....	606
Servicing Questions & Answers.....	608
Operating Notes.....	608
Radio Trade Digest.....	609
RADIO SERVICE DATA SHEETS:	
No. 250—Zenith "Wavemagnet" Model 6D315 A.C.-D.C. Loop-Portable (Chassis No. 5657).....	613
No. 251—RCA-Victor "Pick-Me-Up" Model 94BP4 Battery Loop-Portable (Chassis No. R-C 410).....	615
Book Reviews.....	634, 640



★ THE BIG MAY ISSUE

PUBLIC ADDRESS CONTEST. If you make Public Address installations you will want to enter the Contest, to be described in detail next month, for Public Address installations of prize-winning calibre!

DIRECTORY OF RADIO, ELECTRONIC AND PUBLIC ADDRESS APPARATUS & MANUFACTURERS. Page after page, of classified listings you'll always keep handy.

MASTER CATALOGS. Many pages of manufacturers' complete catalogs and master catalogs!

—All the above, in addition to the usual contents—and at the regular price—in the forthcoming—**ANNUAL CATALOG NUMBER**

★
Published by Radcraft Publications, Inc. Publication office: 29 Worthington Street, Springfield, Mass. Editorial and Advertising Offices: 99 Hudson Street, New York City. Chicago Advertising Office: RADIO-CRAFT, 520 North Michigan Avenue, Chicago, Ill.

RADIO-CRAFT is published monthly, on the first of the month preceding that of date; subscription price is \$2.50 per year in U. S. and Canada. (In foreign countries, \$3.00 a year to cover additional postage.) Entered at the post office at Springfield as second-class matter under the act of March 3, 1879.

Foreign Agents:
London—Goringe's American News Agency, 9A Green St., Leicester Square, W. C. 2, England.
Paris—Messageries Dawson, 4 Rue Fœubourg, Poissonniere, France.
Melbourne—McGill's Agency, 179 Elizabeth St., Australia.
Dunedin—James Johnston, Ltd., New Zealand.

★
Text and illustrations of this magazine are copyright and must not be reproduced without permission of the copyright owners.

★
Copyright 1939 Radcraft Publications, Inc.



H. C. Lewis

QUICK, EASIER WAY ELECTRICITY 12 Weeks

To TRAIN FOR

Practical WORK
IN MY
CHICAGO SHOPS

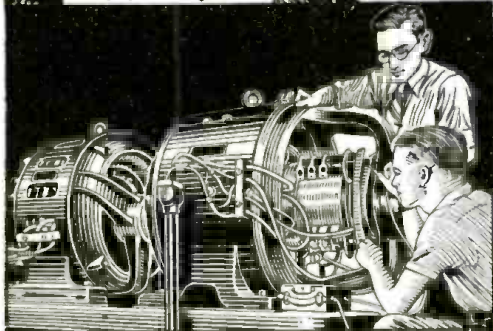

FIRST—You are told and shown how to do it.

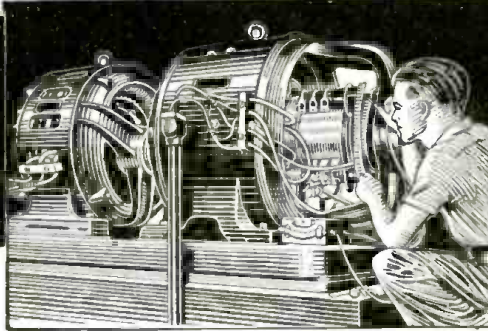

THEN—You do the job yourself.



HOUSE WIRING
only one of the many
branches you
"Learn By Doing."

WANT TO EARN MORE MONEY?

Have you ever dreamed of holding down a steady, good pay job? Have you ever dreamed of doing the work you really like in a job that holds promise of a real future in the years ahead?

Well, we all know that you can't get the good things in life by just dreaming about them. Hundreds of fellows are today holding down mighty fine jobs with prospects of a bright future. They are filling these jobs because they had the foresight to equip themselves with the right kind of training. Most of these men were only average fellows a short time ago, but the proper training helped to lift them out of the low pay ranks of unskilled workers. The same opportunity is now offered to you.

The great fascinating field of ELECTRICITY offers a real future to many men and young men who are willing to prepare for a place in this giant industry.

Here at my school in Chicago, the world's Electrical Center, you can get 12 weeks' Shop Training in ELECTRICITY, that can help give you your start towards a better job.

You will be trained on actual equipment and machinery and because of our method of training, you don't need previous experience or a lot of education. Many of my successful graduates never even completed Grammar School.

Here in my school you work on generators, motors, dynamos, you do house wiring, wind armatures and do actual work in many other branches of electricity and right now I'm including valuable instruction in Diesel, Electric Refrigeration and Air Conditioning at no extra cost. Our practical shop methods make it easier to learn—First the instructors tell you how a thing should be done—then they show you how it should be done—then you do the actual work yourself.



"...Everything was just as stated in literature. And by Coyne methods plenty of instructors to take care of everything, easy to learn. I really was satisfied with Coyne Training."
J. Halyk, Canada



"...Coyne has first-class instructors to teach you the simplest things to start with and they have the equipment to show you these things as you advance..."
Ben Rickman, S. Cas.

I'LL FINANCE YOUR TRAINING

You can get this training first—then pay for it later in easy monthly payments, starting 60 days after your 12 weeks' training period is over—then you have 12 months to complete your payments.

If you need part time work to help out with expenses while training in my shops, my employment department will help you get it. Then after graduation this department will give you valuable lifetime employment service.

Send the coupon today for all details. When I get it I'll send you my big free book containing dozens of pictures of students at work

H. C. LEWIS, President

COYNE ELECTRICAL SCHOOL
500 S. Paulina St., Dept. 49-78, Chicago

in my shops. I'll also tell you about my "Pay After Graduation" plan, how many earn while learning and how we help our students after graduation. Fill in, clip coupon, mail it today for your start toward a brighter future.



H. C. LEWIS, President
COYNE ELECTRICAL SCHOOL
500 South Paulina Street, Dept. 49-78, Chicago, Ill.

Dear Sir: Please send me free your big catalog and full particulars of your present offer, also your "Pay-Tuition-After-Graduation" Plan.

NAME _____
ADDRESS _____
CITY _____ STATE _____

Please Say That You Saw It in RADIO-CRAFT

For the First Time-



The publishers of RADIO-CRAFT are pleased to announce its first annual **MANUFACTURERS' CATALOG NUMBER** *The MAY, 1939 Issue*

The radio manufacturers, in cooperation with the publishers, will spend a young fortune to bring this big issue of RADIO-CRAFT to you—*at no additional cost*—the price remains 25c.

SINCE its first appearance ten years ago, RADIO-CRAFT has faithfully recorded radio progress in all its important phases, month after month, year after year.

For a long time the publishers have felt the need of an important radio service, which is not being rendered by any radio publication today. Therefore, as it has done many times in the past, RADIO-CRAFT again takes the lead with an important radio publishing innovation.

Radio Service Men, Radio Dealers, Radio Experimenters and others actively engaged in radio—indeed the entire radio trade—have long felt the acute need for a comprehensive compendium of the major catalogs of the radio industry, **ALL BOUND BETWEEN TWO COVERS.**

Up to the present time it has been necessary to write to each manufacturer and others in the radio industry for catalogs and circular matter of their equipment. **NONE OF THESE CATALOGS IS STANDARD IN SIZE.** They are, therefore, difficult to file, difficult to keep. They are easily mislaid and lost and, just at the time you need an important catalog, you cannot find it.

For this reason RADIO-CRAFT is now inducing the radio industry to print their key, or master, catalogs which contain the fundamentals of their products, annually in the May issue—**IN A SPECIAL SECTION OF RADIO-CRAFT.**

You will, therefore, get a great many manufacturers' complete catalogs, **FREE WITH EACH MAY ISSUE OF RADIO-CRAFT.** You will no longer have to spend time and postage in writing for

individual catalogs; *they will all appear in your May issue*—**PLUS THE USUAL FEATURES WHICH YOU GET IN YOUR FAVORITE MAGAZINE.**

AND THAT ISN'T ALL!—A priceless, time-saving "who makes what" Equipment Directory of Radio, Electronics and Public Address apparatus will be included, in addition to the Catalog Section, that would ordinarily go to make up the May issue!!

Needless to say, this epoch-making May number will be kept by everyone for a long time. It will be a regular radio-encyclopedia for reference during months and years to come. *You and every radio man* will consult it again and again during the year; and you won't find it necessary to hunt for catalogs all over your home, office, shop, laboratory, etc. Everything will be at your finger-tips.

In return for this great undertaking we naturally want your support—but most of all **YOUR EXPRESSIONS, YOUR THOUGHTS ON THIS UNPARALLELED CATALOG NUMBER.** While we are busy building this issue, we cannot get too many suggestions, too many expressions from you, our readers.

Tell us, therefore, *now, TODAY,* what you think of the idea in general; whether it has your approval, and what else we can do to make this *special number* the success it deserves.

Write to us at once! **THE MOST MERITORIOUS AND WORTHWHILE LETTERS WILL BE PUBLISHED IN THE MAY ISSUE.**

RADIO-CRAFT MAGAZINE
HUGO GERNSBACK, *Editor*

RADIO-CRAFT

'' RADIO'S GREATEST MAGAZINE ''

\$150,118,450 RADIO TIME

By the Editor — HUGO GERNSBACK

VERY frequently a large part of the Radio Industry loses sight of the tremendous potentialities of the radio broadcast business as a whole.

According to the latest available figures, for the year 1938, there were at the beginning of that year, 764 broadcast stations. These stations during 1938 did a combined business of \$150,118,450 gross, most of which was earned by sales for time on the air.

This is a tremendous amount of money and it rivals the rest of the radio industry as far as dollar income is concerned. It also speaks volumes for the American system of broadcasting where the public pays no dues or fees to anyone for the privilege of listening to, admittedly, the world's best radio programs. Only in the United States, can you find such a wealth of high-class music and education put out by our broadcasters, day after day and with steadily increasing quality.

If you have ever been in Europe and listened, as has the writer, for long hours at a time to almost any radio station in almost any country, you will have found the broadcasts to have been very often mediocre and that political speeches and other talks take up most of the time. First-class music and other important broadcasts are few and far between. While in the United States, the matter of radio advertising often proves irksome to the listener, it should be noted that during the past few years the advertising talks have declined in length in order to gain the goodwill of the listeners. Where there used to be harangues of 5 and 10 minutes without let up, the talks have now been scaled down to (very often) less than one minute—except for the smaller local stations. These latter stations which are often hard pressed to make both ends meet, still run a superabundance of blatant radio advertising, but here too, improvements which probably will continue are noted.

Reverting to the amount of the money spent by the radio advertisers, it is curious to note that in this country where there are some 40 million radio sets in existence, 150 million dollars are expended yearly. In other words, the advertisers are spending now at the rate of about \$4 per receiving set to reach radio listeners.

This is not a correct figure, of course, because the 40 million sets probably never are turned on simultaneously. For that reason the advertiser, instead of paying \$4, probably pays between \$6 and \$7 on each set in the hope to catch the ear of the listener.

It would stand to reason therefore, that if the radio advertisers are willing to expend that much money per set, then the radio manufacturers, to my way of thinking, are overlooking a tremendous, big bet. The point I wish to make is that, inasmuch as the radio advertisers must get a hearing, they are vitally interested in having more and more sets turned on as time goes on. It should therefore not be such a difficult matter to pool together all radio advertisers and

have them set aside every year a certain amount of money which could be used to bring radio into the homes of those who still have no radio; a sort of subsidy, in other words.

Of course, I would not advocate giving away radio sets to all those who have not as yet a radio in their homes, but it would pay the radio advertisers to finance the purchasing of such sets over a long period of time. The advertisers thereby would gain millions of new listeners and would be pretty sure to get their money back in, let us say, 2 years. If that idea is not feasible, low-price rentals of good sets for indefinite periods might prove workable.

Each year the radio set manufacturers dump their sets on the market for what they will bring. These sets, instead of being used, as is the custom now, to demoralize the radio set market, would then be bought by the pooled radio advertisers who would get the sets at a low price and who then could afford to rent them out at a rental of 50c a month to those who have no sets.

While all this may sound revolutionary, it is yet a sound idea in the long run and it should certainly be looked into by the radio set manufacturers. It would be one way to do away with the set dumping evil which now bedevils the entire radio set manufacturing industry.

We now come to Television and here a similar situation prevails. As this is written, there are in this country, or will be shortly, only about 2,000 television sets in operation. The fly in the television ointment is that when the television stations start operating within the next 6 months, they will have nothing to broadcast to. In other words, there will only be a spare few thousand television sets to which to broadcast. It will be of vital interest to the broadcasting industry to see to it that television sets are made available as rapidly as possible. The radio advertisers will foot the bill, as usual, because the advertiser will be vitally interested in putting on television programs just as he is in now putting on sound programs.

This is a fact and I believe it also to be a fact that it should not be too difficult to pool the resources of the radio advertisers (as mentioned above) and set aside a sum to be used in popularizing radio sets in the homes of future television-receiver users.

Again my former recommendation of renting television receivers to private owners would work out in the same manner as with sound sets except that in this case the financial operations would be much heavier because of the virgin market for television sets. Even if we are to turn out, say, 5 million television sets per year, it will take us some 6 years or more to place as many television sets into the homes of possible owners, if we assume that there will be an outlet for 40 million television sound sets in this country. I have every confidence that there are that many prospects.

THE RADIO MONTH

SOS

A 20-TON "flying boat" went to an eternal rest in Davy Jones' locker, last month; but not before its blood-congealing "SOS", and that of its Bermuda base, was able to obtain help that saved all but 3 of 13 persons aboard the *Cavalier*.

Stated the Federal Communications Commission, referring to the *Cavalier's* SOS: "... the radio operator of the *S.S. Baytown*, who was not on watch and who was busy elsewhere on the ship, was called to the radio room by the sound of the auto alarm."

The story of heroism and inexhaustible fortitude of passengers and crew, and the lengths to which top-flight technicians of the broadcast networks went to bring an authentic, timely recounting of the catastrophe to radio listeners, is too long to present here.

With one exception, the photos of the broadcast set-up in connection with the Imperial Airways saga were supplied by C.B.S.; RCA supplied the *Esso Baytown* photo. (See "film" at left.)

An SOS cost the lives of 7 men, last month. Answering the international distress call at 3 o'clock in the morning, a crew of 8 set out to aid a vessel in distress off St. Ives, Cornwall, England. Only 1 man survived, when the rescue boat capsized in heavy seas.

Gales and freak storms, marked by thunder, lightning, rain and snow, while the thermometer skidded toward new lows, combined to produce a particularly dirty night on the ocean, last month. The SOS-harvest on the North Atlantic that night totaled 15; with automatic alarms sharing glory with alert radio operators in catching the calls.

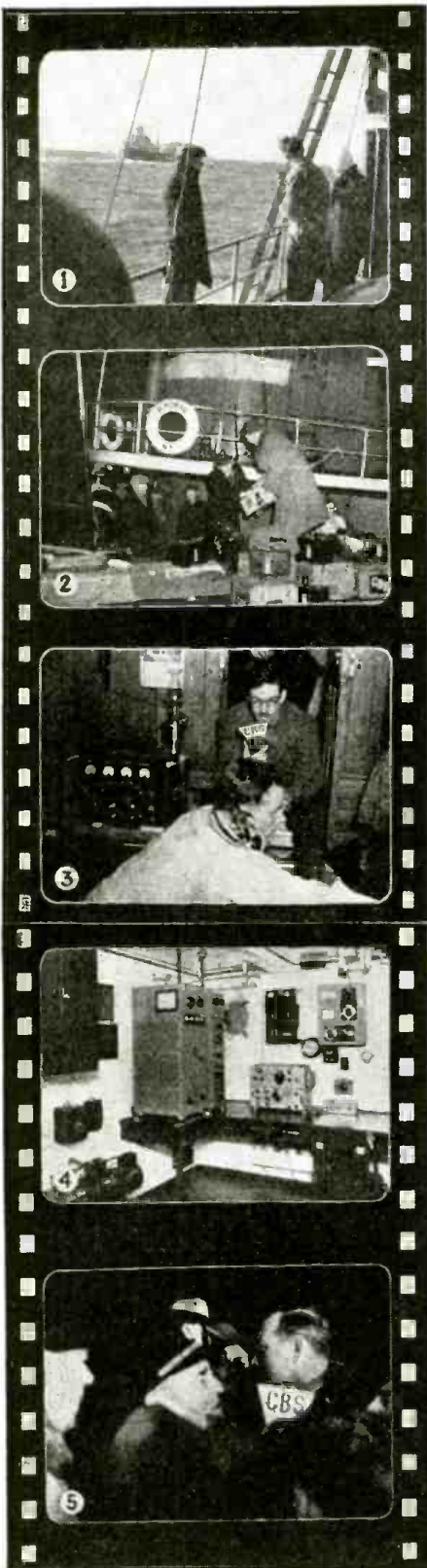

"SOS—CAVALIER"

- 1 George Putnam, aboard tug *M. Moran*, describes rescue ship *Esso Baytown* as it steams toward New York about 25 miles to sea.
- 2 Loading aboard the "gear" required for broadcasting from the tug was no mean job.
- 3 Putnam, aboard the *M. Moran*, kept listeners-in posted regarding the *Cavalier* survivors, etc.
- 4 Interior of the tanker *Esso Baytown's* radio cabin; operator A. R. Hamilton received the first SOS. It has every possible radio adjunct—all of RCA manufacture—including auto (SOS) alarm, and direction finder.
- 5 Capt. Frank Spurr of the *Esso Baytown*, surrounded by camera men, reporters, and a microphone.



Last month a news-bulletin helped save a man's life. Station WOR aired a Transradio bulletin that described the pitiable plight of 65-year-old Harry Battershall, whose life was fast ebbing for lack of suitable blood to combat the ravages of a rare disease. Read with warmth, and received with nation-wide sympathy, life-saving blood donors were quickly located among the great number who phoned to the station during the ensuing 3 hours. *There was no direct appeal made for aid!*

An all-night appeal was made, one night last month, for donors having "type 4, Moss" blood to combat the streptococcus viridans infection of Father Jeremiah Toomey, at St. Elizabeth's Hospital, New York City. The appeal was successful.

INVENTIONS

"RUMBATRON" is Stanford University-ese for a revolutionary discovery, last month, of a means for utilizing the power of rhythmic motion (of electrons) to develop tremendous power at micro-wavelengths. Two rumbatrons, called the "buncher" and "catcher," together with other apparatus, make what is called a *klystron* (from Greek "klyzo," denoting the breaking of waves on a beach). The klystron is being developed by the Sperry Gyroscope Co. (in collaboration with other groups) as a vastly superior blind-landing medium in aviation.

A "50-year life" vacuum tube was described by A.T.&T. Co. vice-Pres. Jewett (who is also head of Bell Labs.), during the "monopoly" quiz in Washington, last month. In short,

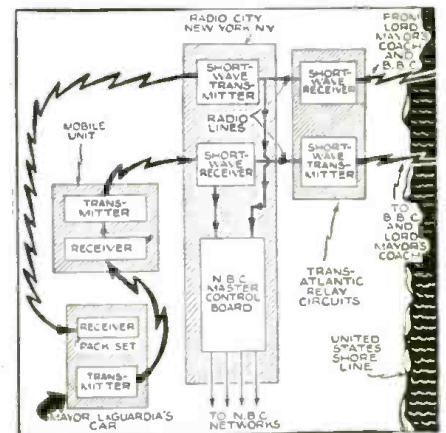

MAYOR'S CAR TO ...

While it lasted it was lots of fun for listeners-in, when New York's Mayor LaGuardia (left), in an auto traveling through the city's Central Park (on his way to the City Hall), held a 2-way conversation with the Lord Mayor of London, who (on his way to Guildhall, London) was traveling in his horse-drawn state coach (see Radiophoto), just

IN REVIEW

tubes now used in wire-telephone service may last 50,000 hours, as against 1,000 hours for ordinary radio-set tubes; the cost is about equal.

BROADCASTING

LEWIS WINNER, genial contributor to *Radio-Craft*, now pilots "Pat. Pending," an entertaining WMCA sustaining program, on the air waves Saturday nights at 8. Give the lad a hand, fellows.

Mr. Fiorello ("Little Flower") LaGuardia, New York's rotund, albeit painfully efficient Mayor, last month hobnobbed by radio with His Lordship (if you please!), the Lord Mayor of London, while both were traveling to their respective offices!

TELEVISION

LAST month RCA announced a decision to almost completely revise its exhibition plans at the New York World's Fair 1939, in order to increase the scope and effectiveness of the television presentation!

During demonstrations in Washington, D. C., to lawmakers last month, announcement was made that N.B.C./RCA plans to transmit by television the inauguration of the next President of the United States, in 1941! Will you—and you—and you, be among the "lookers-in" during what may prove to be a turning point in American history?

FACSIMILE

FACSIMILE is here for the set builder and Mr. John Q. Public! Last month Crosley Radio Corp. announced and demonstrated their new facsimile (Crosley name, "Reado") set-up, which includes making available both kits and complete sets for receiving "radio newspapers," etc., whenever they may be coming over the air. Equipment created a furore at a demonstration before about 200 distributors (and representatives) in convention at Cincinnati.

(Continued on page 632)



CROSLY FACSIMILE

"Reado," the Finch-licensed facsimile unit of The Crosley Corp., is shown above. This "radio printing" system may be used with any radio set delivering 5 watts output. It prints a good picture, from any one of the dozen or more stations; a power supply common to transmitter and receiver is not needed.



W. U. FACSIMILE

The new facsimile system developed by Western Union for future commercial use (as determined by public reaction to facsimile) has a fidelity of 100 lines per inch. Tuning forks control synchronism.

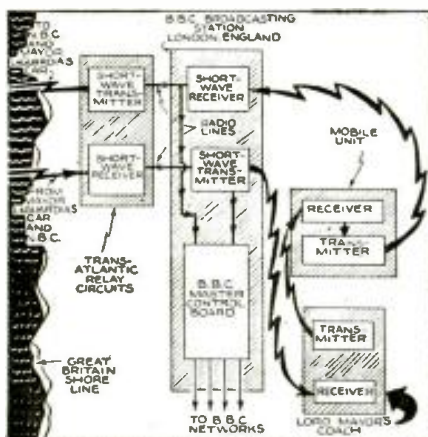

... LORD MAYOR'S COACH after leaving his residence. Mayor LaGuardia's voice operated a transmitter in his car, the signals being relayed by a trailing mobile unit to a shortwave receiver at Radio City where it was put onto the trans-Atlantic radiophone circuit to England; it is understood a similar set-up existed in England. An unretouched RCA Radiophoto is shown at right.



G. E. TELEVISION

The television camera shown above was designed for use in General Electric Co.'s new 5-city "Capital District" television system. Operator's hand is on focusing knob. Red lights below lens glow, signaling the actors when the camera is in operation. More than 250 vacuum tubes will be used in the complete television transmission equipment. (See pg. 585, in this issue; and pg. 545 in the preceding, March issue, for additional illustrations of equipment—including a television receiver—recently developed in connection with 1/2-million-dollar television set-up. Details appeared in the August, 1938, issue of *Radio-Craft*.)

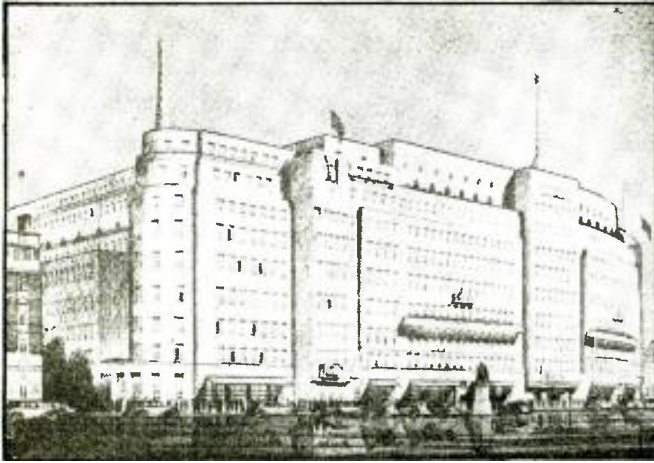

LONDON'S NEW "RADIO CITY"—IN 1940

An artist's conception of how Broadcasting House, headquarters of the British Broadcasting Company, London, will appear when work is completed in 1940, says *Radio-Press-Service*. The site area at ground level is 20,950 sq. ft., compared with the 17,390 sq. ft. of the existing Radio Center. Its 5 studios will be entirely underground. In order to eliminate all possible risk of extraneous noise each of the studios will be constructed as a separate shell, floated and isolated from the building itself. Above the ground floor level the structure is designed as an office building. The depth to which the building will go—54 ft. below pavement level—will be lower than the vaults of the Bank of England. It will probably be London's deepest building.

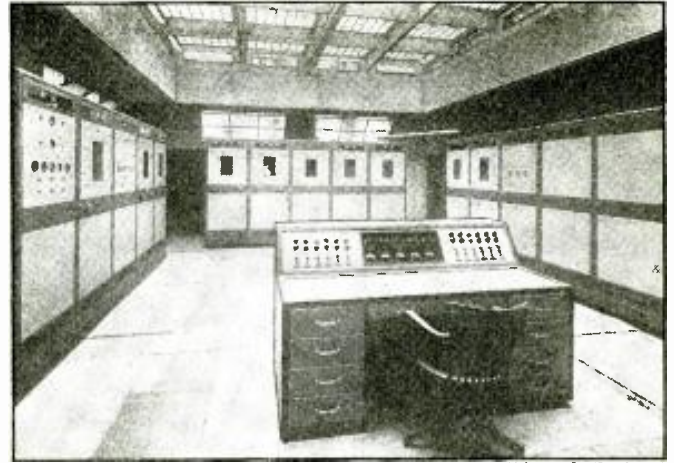

PARIS'S NEW TELEVISION TRANSMITTER (Photo—L. T. & T.)

The output power of the Eiffel Tower station, shown above, was raised to 30 kw. and a new antenna placed in service at the end of 1938. Good reception has been reported all around Paris and also on the South coast of England. The quality of the images compares favorably with those from other transmitters in operation. The Eiffel Tower transmitter is completely A.C. operated. Good stability is obtained by the use of inverted amplifiers, and phase shift is minimized by proper dimensioning of the circuits of the last stage. The response is flat within a few db. and the overall time delay is constant within a few hundred micro-seconds. Transmissions take place about 2 hours daily, 5 days a week; both studio and film transmissions are made.

A Review— **RADIO ABROAD IN 1938**

The following information concerning radio abroad during 1938 has been gathered through associated companies of the International Telephone & Telegraph Corp. in Europe. The article is illustrated with views showing developments, here and abroad, in Television, Radio Broadcasting Equipment, and Aviation Radio.

TELEVISION

PROGRESS toward the adoption of common standards for television services can be recorded for the year 1938 abroad.

Great Britain, France and Germany all adopted *positive modulation* and uniformity of synchronizing signals. The number of lines used, however, differs: 405 in Great Britain; 455 in France; and 441 in Germany. Italy is believed to be following the German practice.

In France, the Eiffel Tower vision

transmitter, ordered by the French P.T.T. from Le Materiel Telephonique, associated company in France of the International Telephone & Telegraph Corp., was inaugurated by the P.T.T. Minister in April. Thereafter, regular broadcasting has taken place about 2 hours daily, 5 days a week, of studio and film transmissions.

A 4-hour daily service is being furnished by the British Broadcasting Corporation, and Great Britain is at present (January, 1939) the only country in the world with a regular television broadcast service. (With the exception of the Don Lee Television System in Los Angeles, we believe.—

Editor)

In Germany, a 25 kw. transmitter adapted to the new German standard is under test.

During the Berlin Radio Exhibition in August, all demonstrations were based on the new standard but were made by local wire connections or from a 100-watt transmitter.

In Italy, a television transmitter was ordered for Rome. Fernseh will supply the scanning equipment. The order for the terminal equipment was received by Societa Italiana Reti Telefoniche Interurbane and the installation is to be similar to that used at the Eiffel Tower where the 0 to 2.5 mc/s signals modulate a carrier, the 2 side bands being transmitted.

Iconoscopes are used almost exclusively for vision transmissions. For film scanning, Fernseh employs mechanical

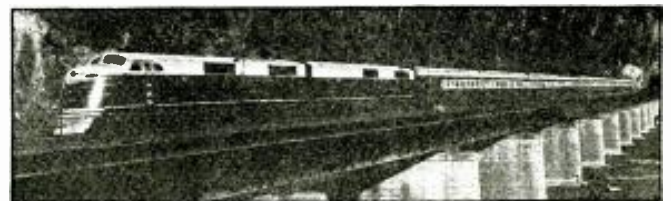

RADIO-EQUIPPED TRAIN

Above is the newly streamlined Capitol Limited of the Baltimore and Ohio Railroad, claimed to be the only diesel-powered all-Pullman passenger train in the East. It is shown here leaving Maryland and crossing the Potomac at historic Harper's Ferry. Among its most modern accommodations and services are the radio receivers shown in the illustration at the left, installed in both club and observation cars. These receivers are the latest General Electric pushbutton table models.

film scanning giving very good images and also a dissector tube using the Farnsworth principle which, in the case of films, gives images comparable with the iconoscope images.

Thus far, with the exception of the 180-line visio-telephone service involving Berlin, Munich, Nuremberg and Hamburg, Germany, no regular long-distance transmission of television images has been realized.

In Great Britain, experiments are being conducted on the transmission of visual signals over ordinary telephone lines. To date, successful pictures have been received over distances of 2-3 miles, and it is hoped to extend this range to 4 miles or more. Thus many important sources of programs may be linked to the balanced-pair television cable encircling Central London. Considerable work also has been done toward the realization of long-distance television transmission over coaxial cables.

The 1938 Berlin, London and Paris Radio Exhibitions, held in August and September, showed important effort toward the commercialization of television receivers, particularly in the case of the London Exhibition.

At the Berlin Television Exhibition, Fernseh, Telefunken, Tekade, Loewe and Lorenz, showed various home-type models of television receivers and also projection-type receivers for large audiences. A total of about 70 receivers was in operation, the majority of which were made by Fernseh.

Fernseh demonstrated a projection-type receiver giving very good 10x12 ft. images. Telefunken showed projection-type receivers giving approximately 3x4 ft. images. A Lorenz projection-type receiver producing a smaller image also was demonstrated.

At the London Radio Exhibition, at least 20 radio set manufacturers demonstrated television receivers at their stands. About 100 television receivers were in operation. Kolster-Brandes, Ltd., an I. T. & T. affiliate, demonstrated 3 types: a console receiver (No. 780) with 20 valves (tubes) producing a picture 10x8 ins. for direct viewing; a similar receiver (No. 790) but more sensitive, incorporating an all-wave radio receiver, and arranged for viewing in a mirror-type cabinet utilizing 26 tubes in all; and a table-type receiver employing 17 tubes and providing a picture 7x6 ins.

Most of the receivers in operation at the London Exhibition were of the direct viewing type, only a few using mirror viewing. The quality was very uniform.

Projection-type home receivers giving images between 18x15 ins. and 24x20 ins. were also demonstrated by Baird, Marconi, Philips and Scophony. The image of the Baird receiver was black and white, while the images of the other projection-type receivers were of a light greenish-yellow color.

At the Paris Radio Exhibition, about 14 television receivers were demonstrated by 5 firms, 2 of them only offering receivers for sale.

During 1938, the trend in television

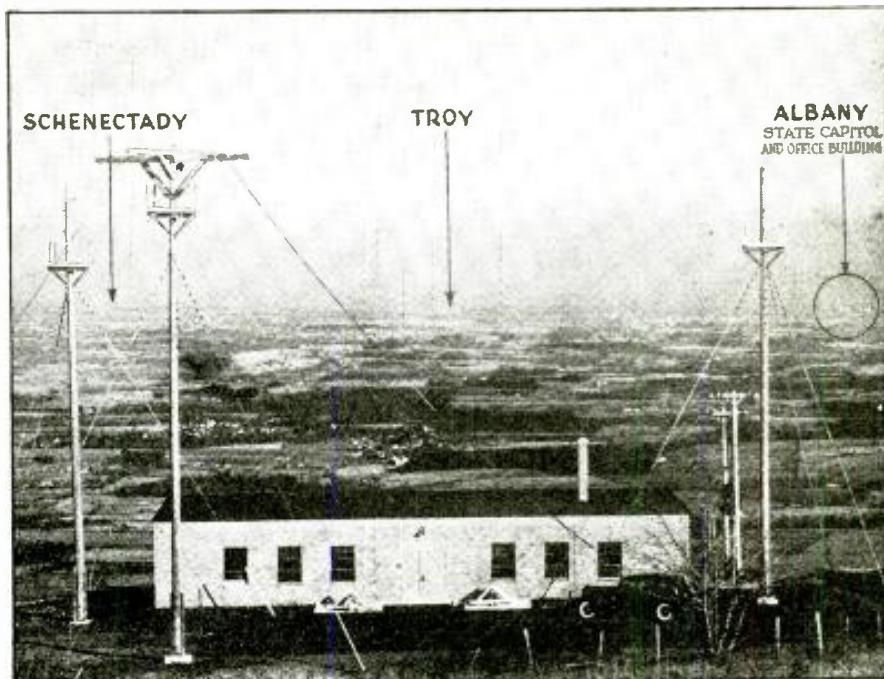

"CAPITAL DISTRICT" TELEVISION

The new General Electric television transmitting station with a power output of 10 kilowatts will cover an area comprising Schenectady, Albany, Troy, Amsterdam and Saratoga, known as the Capital District, with a combined population of more than 500,000. The tower to the left will support the receiving antenna, picking up studio signals radioed from Schenectady; the next will be used to broadcast the televised pictures, and the one to the right will broadcast the voice with the picture. The small pole to the right is part of the power line, brings electricity up the mountainside to the station. In all, General Electric has permission to construct 4 television stations, 2 for Schenectady, New York, and one, each in Albany and Bridgeport, Conn. The frequency band for the Albany and Bridgeport stations will be 60,000 to 86,000 kc. and for the Schenectady stations 42,000 to 56,000 kc. (See "500,000 Television System!", August 1938 issue of *Radio-Craft*.)



AUTOMATIC DIRECTION FINDER

New Sperry-RCA Automatic Direction Finder installed in American Air Lines Douglas Sleeper. Photo shows W. H. Dum, American Air Lines pilot, left, and Lieut. Richard Burke, U. S. Coast Guard, Commander of Coast Guard Air Base at Cape May, New Jersey, discussing the operation of this device after demonstration flight at Floyd Bennett Field last year. This Direction Finder, when once tuned to a station, points continuously and automatically at the station so that the pilot need pay no attention to its operation, merely glancing at the pointer on its face!

receiver construction was towards the reduction of the size of the cabinet with respect to the image dimensions. This was accomplished mainly by decreasing the length of the cathode-ray tubes.

The number of tubes in television receivers was reduced appreciably. Most receivers utilized between 13 and 20.

The majority of the receivers used magnetic-type cathode-ray tubes; an important proportion, however, still employ electrostatic-type tubes.

The prices of the television receivers shown at the London Exhibition ranged between 21 gns. (\$103) for 4x3½ ins.

direct viewing types and 220 gns. (\$1,082) for the 20x24 in. projection type.

It is estimated that the number of television receivers in service in England at the time of opening of the London Exhibition was between 8,000 and 10,000, and that at least the same quantity was sold during the exhibition.

RADIO BROADCASTING EQUIPMENT

Progress in 1938 abroad in the development of broadcasting equipment as in 1937, was characterized mainly by
(Continued on page 634)

MANUFACTURED SPEECH!

Truly a product of the "World of Tomorrow", Bell Laboratories' latest contribution to electronic science is an incredibly ingenious device designed for exhibition at the San Francisco Exhibition and the New York World's Fair 1939. The ability of "Pedro, the Voder" to CREATE human speech from vacuum tubes is incontestably demonstrated!

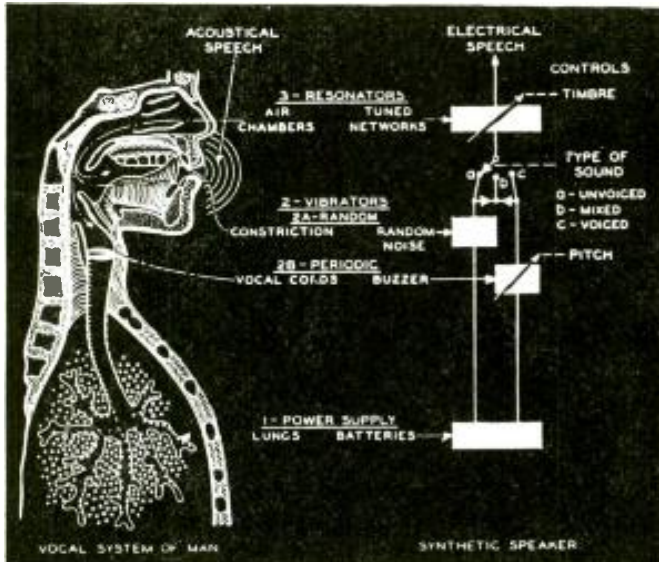

cavity; that is the way in which are made all the sounds of speech when one whispers, and such sounds as *s*, *th* and *f*. In the Voder there is an electrical hiss, and with some of the keys the operator can control its quality so as to make those sounds. Other keys make the "stop consonants" like *d*, *k*, and *p*.

Another kind of sound enters into human speech, most importantly in the vowels, like *a*, *e* and *o*. It comes from the vocal cords, and is very complex and somewhat musical. In the Voder, therefore, there is an electrical source of sound corresponding to the vocal cords; and there is a pedal for changing its pitch and for giving to speech a rising or falling inflection as desired. When the operator wants the sounds made by the vocal cords, instead of whispered sounds or consonants, an arm rest switch is depressed. Then the particular parts of this vocalized sound which are wanted are selected by playing the proper keys.

A GENTEEL OCCUPATION

In order to give a clear conception as to how the Voder operates, it might be well to describe a test which Mr. Watkins set up to determine the aptitude of young ladies for playing the machine. The young lady was first seated at the machine and then asked to drop her fingers on all the keys at one time. The result was simply a loud noise which was probably about the equivalent of what one would expect to receive from the vocal cords if there were no head on the body with cavities to act as resonators. She was instructed to play separate keys until she found one which sounded like the vowel *E*. She was then asked to hold this key down and then play other combinations of keys to get one which used in conjunction with that one would sound more like *E*. Having found *E*, she was then requested to raise her forearm from its arm rest, changing the factor of the keys from vocalized to breath sounds. She was then asked to manipulate the keys until she found a combination which sounded like the breath sound *CH*. She then had the *E* and *CH*.

Next she was told to depress the keys which made the sound *E* and to place her foot on a foot pedal and raise the pedal up and down. She then got a rising and falling inflection of the vowel *E*. She was then told to play *E* (rising and falling inflection) *CH*. This gave her the word *EACH*.

It can readily be seen that the instrument has not been an easy one to master, as to produce finished speech on the apparatus requires not only a sense of rhythm, a fine touch, a good

(Continued on page 616)

AN electrical device which, under control of an operator at a keyboard, actually talks was demonstrated recently at the Franklin Institute, Philadelphia!

Known as the *Voder* (Voice Operation *DE*monstrator*R*), it is a development of Bell Telephone Laboratories as a scientific novelty to make an interesting educational exhibit for the Bell System's displays at the San Francisco Exposition and at the World's Fair in New York. It is built, except for its keys, entirely of apparatus used in everyday telephone service.

The Voder creates speech. It is the first machine in the world to do that. Individual vowels and consonants have been made by a variety of instruments, but they have never been linked into connected speech. Seated at a keyboard something like that of the old-fashioned parlor organ, an operator can carry on a conversation simply by pressing keys, singly or in combination. It takes a good deal of practice and some time to learn—not as much time as it takes the human to learn the mechanisms he is born with, but still quite a while. And it talks with what might be called a slight "electrical accent." Nevertheless a skilled operator can make it say what she wants.

CONSONANTS—VOWELS

Designers of the Voder provided it with electrical equipment corresponding to the two kinds of speech sounds. One kind of sound is made by forcing the breath through the mouth, past tongue, teeth and lips. Turbulence in the air-stream sets up a hissing sound which contains a great many vibration-frequencies. Some of these are reinforced by resonances in the mouth



Seated at the keyboard of the Voder this young lady can carry on a conversation by pressing keys.

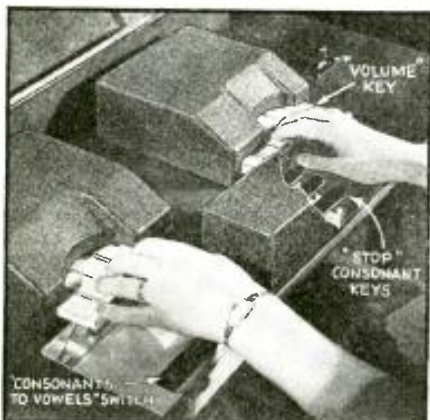

A close-up view of "Pedro, the Voder." Ten of the white keys each controls a speech sound. The 3 black keys make the "stop" consonants.

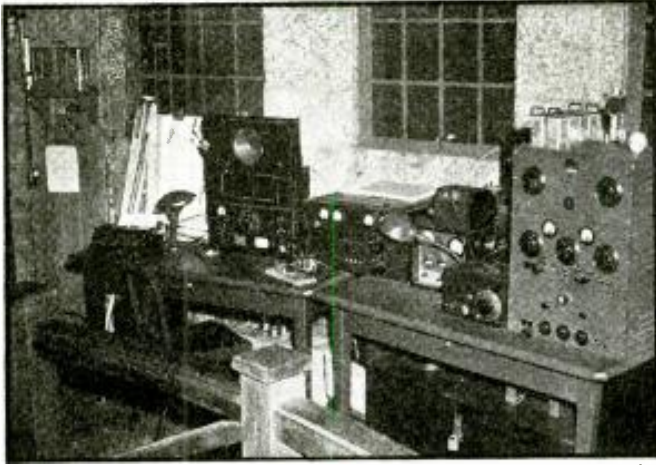

A corner of Whiteface Observatory, showing radio and meteorological equipment. To withstand high winds and severe cold, building is constructed of granite and steel. Its architecture and material blend with the mountain's summit of bare rock.



Shelter house on summit of Whiteface Mountain, in the Adirondacks, where Rensselaer Polytechnic Institute and New York University conduct meteorological and radio research. From here, radio operators, almost completely isolated, send out 7 times a day weather data for use in forecasts.

RADIO. WEATHER STATION—1 Mile Up!

Mr. Elbert F. Corwin, Managing Director of the Whiteface Mountain Meteorological Observatory, has approved the following article. It was written specially for RADIO-CRAFT by a student of Rensselaer Polytechnic Institute who spent last summer at the snow-bound Observatory as a radio operator, to aid you—and you—and you, dear readers, in receiving accurate weather news.

WALTER A. KNOOP

*Radio Operator and Weather Observer at Whiteface Observatory
During the Summer of 1938*

WFAH, WFAH de W8XYR, Whiteface Mountain calling"—such is what one hears on 4797.5 kc., every 3 hours throughout the day and night except 4:30 a.m. This signal originates from the Whiteface Mountain Meteorological Observatory, located near Lake Placid, New York, in the Adirondacks. The Observatory is jointly operated by New York University and Rensselaer Polytechnic Institute in cooperation with the United States Weather Bureau.

The Observatory is located at the summit of the mountain, 4,872 feet above sea level. To the radio-minded person this suggests excellent opportunities for ultra-high frequency work, as well as varied communication maintenance. The latter is of paramount importance, because of the necessity of having a reliable method of transmitting weather messages every 3 hours to Albany Airport, 115 airline miles South.

At Albany, all reports, including those from the Mt. Washington Observatory in New Hampshire, which are relayed through Mt. Whiteface, are put on the teletype circuit for use by the Weather Bureau in many parts of the country. Telephone communication is unsuited to the extreme weather conditions, unless the wire is buried underground.

During the Summer months lightning

is prevalent, frequently rendering the land line useless. In the Winter, winds sometimes reaching 100 miles per hour, or over, and rime ice formation bring down all telephone lines and render them useless. Rime ice and wind are also great sources of trouble in maintaining antennas. Even copper-clad steel with 14-inch pyrex insulators seems to be inadequate for the strain that Mother Nature puts upon antennas. Phosphor-bronze wire with oak insulators has been decided upon for use this Winter.

During the Summer, moisture is a constant source of trouble. Last Summer the relative humidity averaged almost 90 per cent for one entire month. It is easy to visualize the effect on cables, transformers, condensers and insulation.

Power is obtained from a 4,600-volt, 3-phase underground cable line running along the 8-mile Memorial Highway from Wilmington to the mountaintop. At the end of the highway, this is transformed to 110-220 volts for lighting and also for power for an elevator running up 276 feet through solid granite to the very summit of the mountain. An 800-watt Kohler auxiliary 110-volt generator is also available, and automatically furnishes power the moment the regular source fails.

(Continued on page 623)



Winter at the Observatory included making close friends with a heater. Mr. Benjamin Schiffer is here shown at work in the temporary quarters. That is a speed key he is using to put copy on the air.



Mr. Bertrand F. Lee now engaged as an observer at Mt. Whiteface was formerly a radio operator on one of the Pan American ships operating between Florida and Trinidad, South America. You are now peeking in at Mr. Lee doing his stuff at the Observatory.



← Major Edwin H. Armstrong (seated) and Dr. W. R. G. Baker double-check the laboratory performance of the new General Electric experimental-type frequency modulation receiver; inset—the completed 11-tube receiver.

Interior of radio station W2XMN atop the Palisades (N. J.) near the George Washington Bridge; this transmitter employs frequency modulation. Static-less radio programs will soon be transmitted, on 40 mc. (about 7 meters), over a service area of about 100 miles. Control desk is shown in foreground.



At Long Last—STATIC-FREE RADIO!

This Spring, the first high-powered, static-less radio station in the world employing an improved system of transmission and reception will be put into operation, Major Edwin H. Armstrong announced last month. "Frequency Modulation" is the secret.

THE new Frequency Modulation System (as contrasted with the usual Amplitude Modulation System heretofore universally employed) invented by Major Armstrong, because it wipes out static, tube noises and interference is expected to replace the old method now used, in much the same manner in which alternating cur-

rent replaced direct current. It will greatly relieve the danger of the air waves being monopolized, which has given so much concern to Congress, by making available a service on the ultra-high-frequency channels that are comparatively unused at present.

ULTRA-HIGHFIDELITY FOR 'QXR

Arrangements have been made with station WQXR for the new station to receive and transmit the programs now broadcast from New York's "High Fidelity" station. Mr. John V. Hogan, radio engineer and owner of 'QXR, has filed a petition with the Federal Communications Commission for permission to build a *frequency modulated* station in New York City. The studios and programs of WQXR will be used by W2XMN until such a time as Mr. Hogan's own station is erected.

Construction of *frequency-modulated receiving sets* of the new type, which were at first labeled an "impractical dream" by radio corporations, has already been started on a commercial basis by General Electric! The new sets, when produced on a quantity basis, will cost no more than the ordinary good set of today and will be able to receive both the old and the new kinds of broadcasting much the same as sets now receive both the short and long wave programs. Arrangements are being made for manufacture and sale of transmitters by the Radio Engineering Laboratories of Long Island City. Patents on the system have been granted to Major Armstrong in the important countries of the world.

Station W2XMN, built in a wooded section of Alpine, N. J., atop the Palisades, has a 400-foot tower with three 150-foot crossarms. The tower is constructed in an entirely new design per-

fect by Major Armstrong and, rising 1,000 feet above sea level, can be seen from almost any spot along Riverside Drive. Instead of the conventional wires strung between two supports, the aerial consists of a series of copper-plated steel bars fastened to a boom suspended between the tower's cross-arms. *Waves sent out over these bars may be concentrated along the earth's surface*, whereas the waves broadcast by the ordinary wire aerial go off in an arc in all directions.

Major Armstrong received the medal of the Institute of Radio Engineers in 1917 for his development of *regeneration*; is also the inventor of the super-heterodyne receiver (which is in use today in nearly every radio set having more than 3 tubes).

Two similar stations, built on an experimental scale are in existence, one in Albany, N. Y., owned by General Electric, and the other at Storrs, Conn., erected by Professor Daniel Noble of Connecticut State College. Six other stations are being constructed in the East by radio engineers who, Major Armstrong reported, "believe that the new system will prove itself so superior to the old method that it will be universally adopted." One of these stations, being constructed by the Yankee Network on Mount Asnebumskit near Worcester, Mass., will be at least the equal to W2XMN in power and performance.

W2XMN is at present assigned to broadcast in the vicinity of 40 megacycles (about 7 meters). While this is an extremely short wavelength judged by ordinary standards, the invention can be used equally effectively on still shorter wavelengths.

(Continued on page 618)

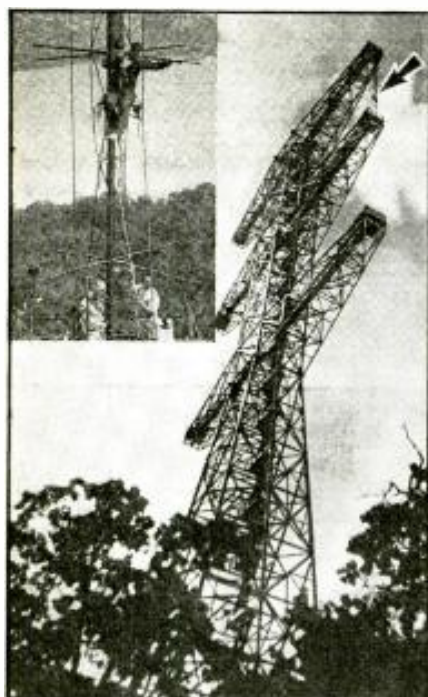

(Inset Photo—Norman Monroe, Alpino Police.) The adjustment of this antenna (shown during the early stages of its construction), located at Alpine, N. J., proved to be the most difficult part of the whole construction. For a period of 2 months last summer Major Armstrong sat in a boatswain's chair (see inset) several hours a day 400 ft. up regulating the transmission lines. "As this had to be done with the power on, the combination of dodging the high voltage and the frequent thunder storms made the day's work always an interesting one," Major Armstrong said.



Fig. 1. Here are the "voice" controls, of the Novachord, which convert an otherwise string-less "piano" into an entirely new electronic musical instrument.

Announcing The "NOVACHORD"

Electronic Music's New 163-Tube "Baby"

Laurens Hammond—45-year-old inventor of the famous 9-tube electronic organ which bears his name—now introduces to radio dealers and Servicemen a new 163-tube, multi-tone, string-less electronic "super-piano." You'll soon hear it on the air!

THE Novachord (*nova*, meaning new; and *chord*, pertaining to music), latest contribution of Laurens Hammond to the field of electric music, is an entirely new musical instrument. In form it resembles the old-fashioned spinet, having a single manual keyboard of 72 notes which are played exactly as a piano. It also has the regulation piano sustaining pedal and its volume is controlled by a swell pedal similar to that of an organ.

There the physical resemblance to the piano ends. Its tones are produced entirely electrically by means of circuits of 163 ordinary vacuum tubes. It contains no pipes, reeds, strings, hammers or vibrating parts. Its tones (or "voice") can be varied over wide ranges by means of simple controls mounted on the front panel above the keyboard. (See Fig. 1.) These, broadly speaking, are divided into 2 groups. One group on the left controls the actual tone color by varying the harmonics. The other on the right varies the so-called "envelope" of the tone, a term used to describe the speed of attack and decay.

THE ELEMENTS OF MUSIC

Physicists long ago learned that musical sounds are essentially a regular vibration of pressure waves in air, and that the character of this wave determines what we call the "pitch" and "quality" of the sound. That is, the frequency of fundamental vibration of a musical note determines the pitch, while the number and relative intensity of the harmonics, at other rates of vibration, determine the tone color.

In addition to the pitch and quality, the rate of incidence and decay of the tone contributes much to the difference in sound that we hear from the various musical instruments. For instance, a percussive type of tone, like the piano, rises almost instantly to the top of its dynamic curve and dies away slowly unless the key is released, causing the dampers to stop the strings vibrating. The singing tone of strings and woodwinds starts low in the dynamic scale, builds quickly to a peak, and may be caused to continue at that level or decay slowly, at the will of the player.

The methods by which these factors are varied and controlled in the "Novachord" is amazingly simple, in view of the complexity of the results.

"FREQUENCY DIVIDER" TUBES

A bank of 12 standard vacuum-tube oscillators, tuned to the 12 half-tones in the highest octave of the instrument, supplies the original impulses from which all other notes are derived. Each octave, except the highest, uses 12 "divider" tubes whose function is to divide by two, exactly, the frequency received from the octave above. In this way, the frequency of all the "A's", for instance, is controlled by the "A" oscillator in the top octave.

There is associated with each note of the Novachord, a "control" tube which determines the attack and decay of the note as well as its quality or timbre. The control tubes receive their signal from the oscillator or "divider" tube that supplies impulses at the required frequency. The action

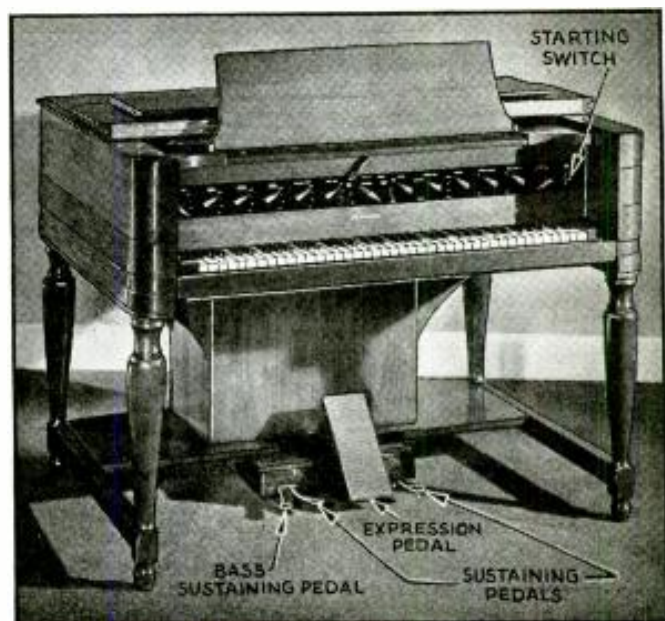

Fig. A. Newest development of the manufacturers of the Hammond electronic organ is the Novachord shown above. Unlike the Hammond Organ it contains individual tubes for each of 72 notes.

of the "control" tubes is in turn controlled by the electrical circuit connected to each playing key, and by the control switches placed on the panel above the keyboard. The foundation tone produced by the control tubes is very rich in harmonics, and is particularly suitable for modification by the various controls provided in the instrument, to give almost any tonal effect desired by the player.

PANEL CONTROLS

The controls to the left of the center of the panel are of the nature of filters, and are designed to accentuate or suppress a particular band of frequencies and so affect the color of the tone. In the center there is the "Brilliant" to "Mellow" switch which, in the latter position, brings in a muted effect. The other center control provides a means for adjusting the balance between bass and treble. There is also the *attack* control which determines the dynamic curve of incidence and decay of the notes. The *vibrato* controls are worthy of special mention since they provide a true pitch vibrato and, as no more than 2 notes in any octave are caused to vibrate at the same rate, the random arrangement produces a peculiarly warm and rich vibrato. Finally there are the *volume* switch, and a combination control that operates several of the switches simultaneously for rapid changes from *percussion* to *singing* effects, and back again. The *dynamic* volume is controlled by a foot-operated Swell or "expression" pedal (see Fig. A) which controls the volume

(Continued on page 630)



The complete, modern, Audio-Spectrum-Controlled Amplifier for Recording and Playback. The front panel controls from left to right are: plug-in jacks for 2 microphones, channel No. 1 voice-coil control, channel No. 2 voice-coil control, low-pass control, band-pass control, high-pass control, all-pass control, master switch and above it, the pilot light. Decibel-voltmeter posts are atop case.

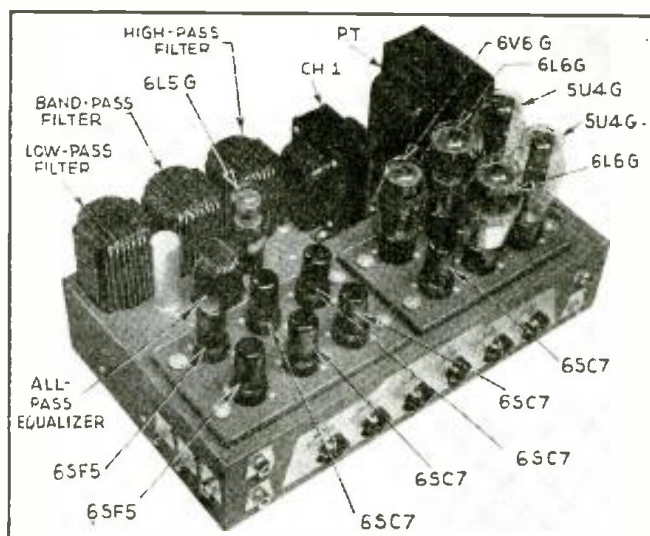

The amplifier with its cover removed. Note that all the tubes are mounted on separate plates which are rubber-floated on the main chassis. The controls on the left side of the chassis are, from left to right: dialogue filter switch, phono-mike switch, phono input. The controls on the front apron are explained in the caption to the left.

A MODERN AMPLIFIER *For Recording and Playback*

A. C. SHANEY

RADIO-CRAFT readers are here given a complete description of a broad-band, audio-frequency-controlled amplifier with concentric feedback, tetrode degenerative driver, stabilized power supply, dialogue filter, electronic frequency mixers, which enable the production of high-quality recordings by laymen and expert recording engineers. The amplifier also provides for high-fidelity, "pleasant" playback of recordings though they be markedly deficient in high, low, or middle frequencies.

THE fundamental problem of high-fidelity recording evolves itself about the ability to pick up, amplify, record, and play back signals in exact accordance with their original rendition. Naturally, this in itself, is an impossibility with present types of recording equipment, inasmuch as the effect of auditory perspective is lost unless 2 distinct pickup recording and playback channels are employed with corresponding placement of speakers and microphones. In lieu of this defect, the recording engineer is faced with the problem of recreating as closely as possible the sound quality, tone, volume dynamic range, etc., of the original rendition.

As a long chain of components are interlinked between the original pickup and final playback (each of which has a decided bearing upon the ultimate result), we must of necessity, confine our discussion to the amplifier only, and outline a general operating procedure to compensate for the more common defects in the interlinked apparatus.



The Audio Spectrum Controlled Recording and Playback Amplifier which is diagrammed in Fig. 1, is essentially a high-fidelity, 2-channel input amplifier with a set of low-pass, band-pass, and high-pass filters for broad-band equalization which provide a ready method of analyzing and correcting the quality of sound picked up.

It is well known, in the recording field, that it takes an expert to properly orientate musicians and microphones, as well as correct for studio acoustics in order to maintain the proper balance between the various instruments so as to ultimately produce a

pleasant-sounding record. That many an expert has gone wrong in this initial requirement is easily proved by analyzing a number of commercial records which are usually made under ideal conditions with high-priced equipment. Deficiencies in low- and high-frequency response can easily be detected by analysis with this amplifier. (The method of procedure is discussed under the heading "Audio Spectrum Control Analysis.")

FLAT FEET, FLAT TASTE AND FLAT RESPONSE

The question of frequency response and equalization undoubtedly receives more attention from recording engineers than any other one subject in the field. Most recording technicians are always equalizing one component or another, continually striving to attain perfection—using as standard of comparison some abstract ideal.

It is a popular misconception that the fidelity of a recording is limited by the frequency characteristic of the recording amplifier or cutting head. (Aside

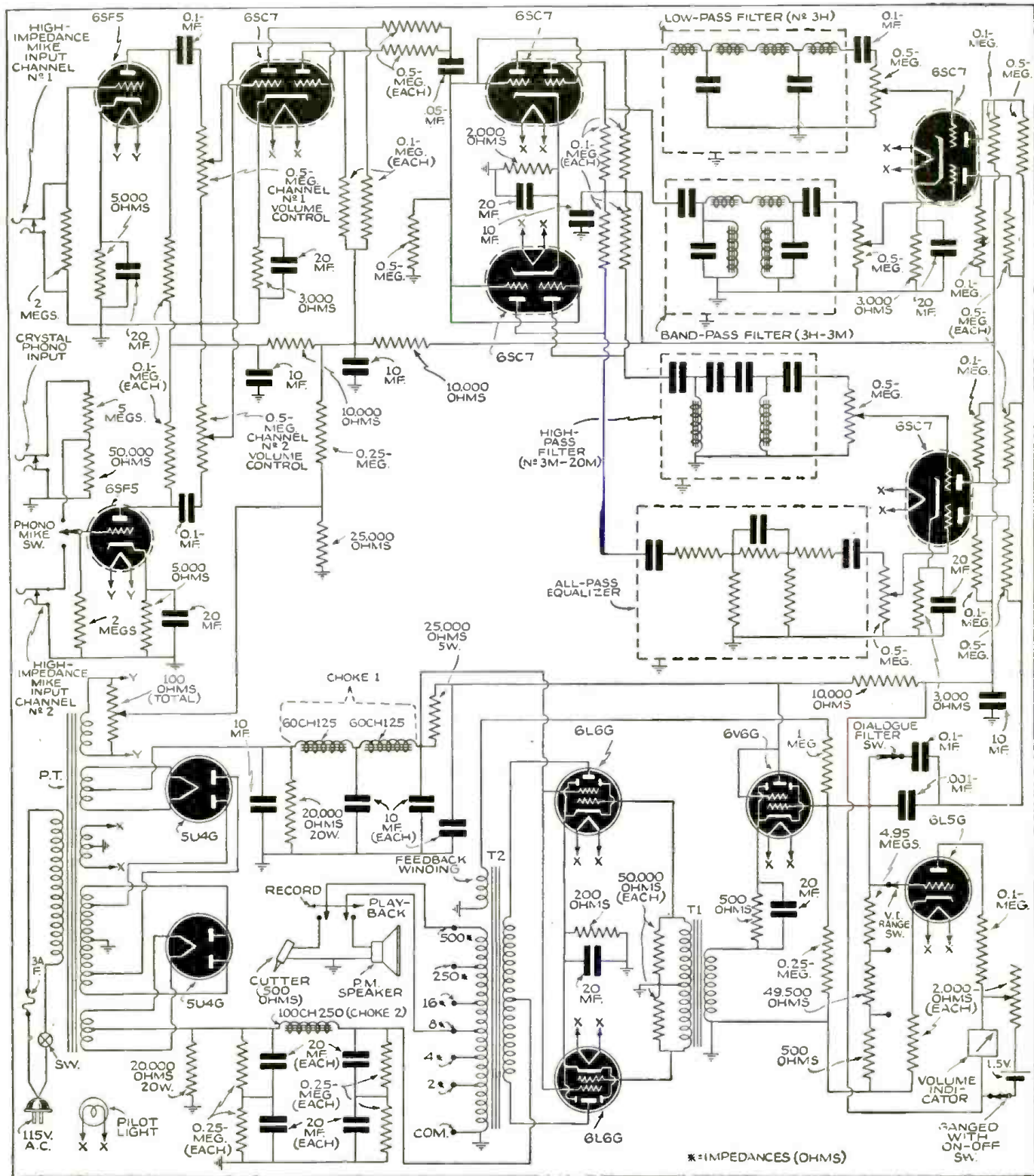

FIG. 1.
Complete schematic diagram of the Audio-Frequency-Controlled Recording and Playback Amplifier.

from the limitations imposed by surface noise and needle tracking problems.) As a result of this belief, some engineers feel smug in the knowledge that their recording amplifier and cutter are "flat" (that is, respond equally to all frequencies).

Like flat feet and a flat taste, a "flat response" in a recording system is not always an ideal state of affairs. This can easily be proven by honestly appraising a recording made with a flat

amplifier and flat cutter; or a compensated amplifier for a particular cutter.

THIS RECORDING BUSINESS

Actual experience, while developing professional recording amplifiers for one of the largest record companies in America, has brought to light a number of interesting facts which lead the writer to believe that the amplifier described in this article is an ideal unit

for the serious-minded recording technician.

Among some of the unusual facts uncovered during actual studio work are included:

1. A supposedly properly-compensated amplifier and cutter not always produce pleasant records.
 2. Paradoxically, some orchestras actually sound distorted while
- (Continued on page 614)



The RADIO-CRAFT plan for a Radio Home with reception in every room, opens up for the industry a vast new market which will benefit the consumer, the radio dealer, jobber and manufacturer, and the radio Serviceman.

PART III

N. H. LESSEM

WHAT luck! Just because we're anxious to get the "Radio Home" completed in the shortest possible time, we run into the darndest weather for building.

The result?—a cockeyed building schedule, no story in the March issue and almost no story in this one. We had planned on winding-up this series of articles with the 3rd instalment covering all the wiring steps. Now however we'll divide it in two: namely, preparing the master receiver to function with the built-in remote speakers and tuners; and, next month (when we have the Home completely finished—we hope), the actual wiring of the system. And perhaps it's just as well, too for there's plenty to say about the adaptation of the master receiver.

Everything that follows then, is in connection with the master receiver, and all parts mentioned will be mounted inside the large console cabinet, in close

proximity to the chassis (see Fig. E).

OFF-ON RELAY

First, we must have a relay so that the set can be turned on and off remotely. (Remember that pressing any of the remote "station" buttons both turns the set on and tunes the station; and pressing the "off" button turns the set off.) The relay does this job. Although taken from an old RCA-Victor remote-controlled set of several years back, any relay which will perform similarly will do.

This particular unit (item 7 in Fig. E) consists of 2 "solenoids" (or windings) with a common armature between. The armature is of the holding type, i.e., when attracted to either of the windings it will stay there until the opposite winding is energized. These windings (one for "on" and one for "off") are designed for 24-volt operation, either A.C. or D.C. although it will work well with 15 volts, and up. In our setup we use 16 volts A.C., supplied by the

"TELECHIME" transformer which is always across the line. Hence the relay is always ready for instant action.

Then, we must have a transformer for the extra pilot lights used to light the station tabs in each of the rooms. Although there is reserve current in the power transformer of the master receiver to handle these extra lights, we decided not to disturb the set in any way. If 6-8 volt pilot lights are used then an ordinary "bell-ringing" transformer, bought in any radio or hardware shop, is just the ticket. (We use a 6.3 volt transformer simply because we had one on hand. See item 5 in Fig. E.)

This unit must be so connected that it will go "on" simultaneously with the set. The simplest way to do this without actually tying both linecords together, is to use an ordinary base-mounting-type double outlet as shown in Fig. E, item 6, and in Fig. 5. The relay is then wired to "make" and "break" the current to this outlet, and thus control the receiver and pilot light transformer at the same time. Another feature is that any radio light-ornament can be plugged in too

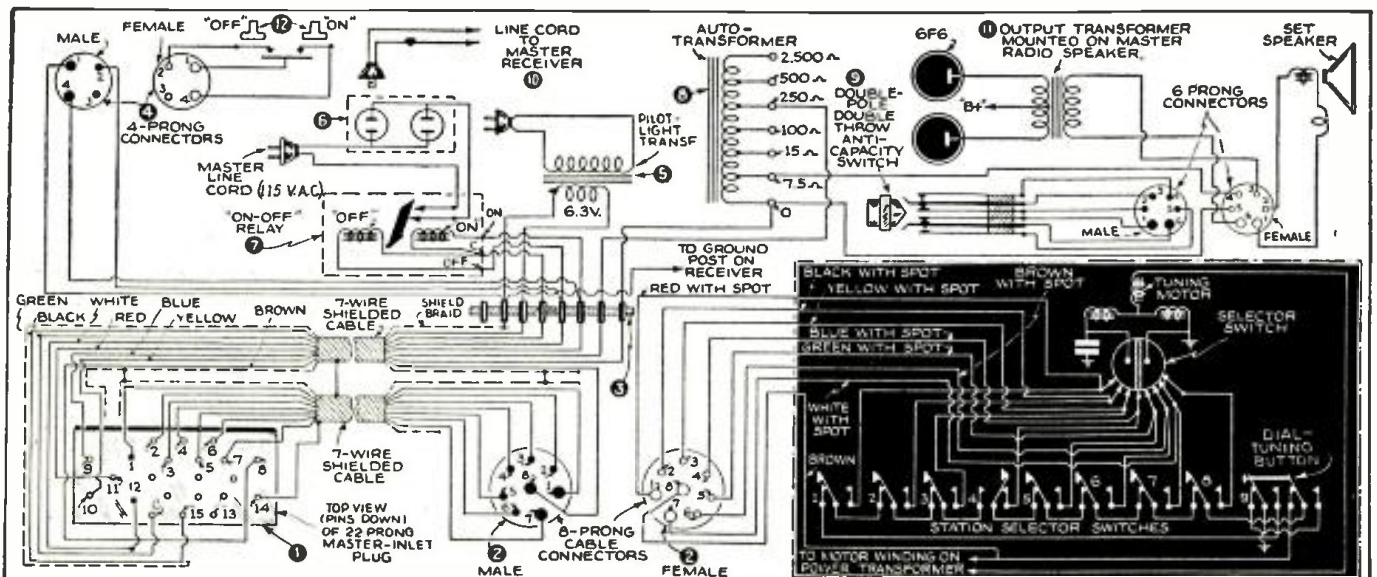

Fig. 5. Complete wiring diagram for connecting the pilot light transformer, impedance matching autotransformer, "on-off" relay, "set-system" switch and other components to the master receiver in order to adapt it to the built-in radio system. The numbers in the circles correspond with those in Fig. E and serve to identify the units pictorially. All connections to the chassis itself and to components mounted on the tuning panel are made through plug connectors so that the chassis may be easily removed for future servicing.

and thus be turned on together with the receiver. The set itself thus far, has not been altered in any way.

The power switch on the set should now be short-circuited so that the set is always "on". This step may seem superfluous to some readers but it is really necessary for if the switch is left in the "off" position the entire system will be inoperative. The "on-off" relay will operate and the pilot light transformer will go on but the set will not operate because its own power switch is turned off. Therefore, in place of the power switch we must install 2 pushbutton switches of the *momentary-contact* type. These operate the relay in the same way as do the buttons on the walls. Thus the set can be turned "on" at any of the remote points and "off" at the receiver; or vice versa—making the entire "on-off" operation foolproof. These pushbutton switches are homemade affairs as can be seen from Fig. 5. (The buttons themselves are from an old broken-down set analyzer.) Their position on the front panel is shown in Fig. F, item 12.

Also shown on the panel is a double-pole double-throw switch (item 9). The purpose of this unit is to switch to and from the set and the remote speakers. Either the push-pull or toggle type may be used. We use the latter simply because we happened to have one handy. Fig. 5 shows all the connections to this switch.

AUTOTRANSFORMER

Finally, and most important of all, we have the impedance-matching autotransformer. This unit, an RCA type MI-4603 will permit a sufficiently good matching of impedance between the receiver and the 6 remote speakers. Although the relationship between proper impedance-matching and distortion is not very critical here (since we are dealing with a *current* rather than a *voltage* system) we should nevertheless try to get the match as close as possible;—and this transformer makes it possible in a practical way. The transformer has 7 terminals labeled with figures.

These represent impedance values of from 7.5 ohms to 2,500 ohms in 6 steps. These terminals may be used therefore to *directly* determine and arrive at a large number of impedance-transfer ratios—among which must be the one best suited for us. At best, the impedance match will have to be a "happy-medium" one since the *impedance of the built-in speaker system will vary depending upon how many of the speakers are in use at any one time.*

WIRING DIAGRAM

Figure 5 is a complete wiring diagram showing how all the units mentioned above are connected. Fifteen wires in all are run down to the 22-prong "Master-Inlet" plug (item 1 in Figs. E and 5). These comprise two 7-wire shielded cables—shields being 16th "wire." All shields are bonded (soldered) together in several spots. Since the two 7-wire cables are identical in color coding it is necessary to

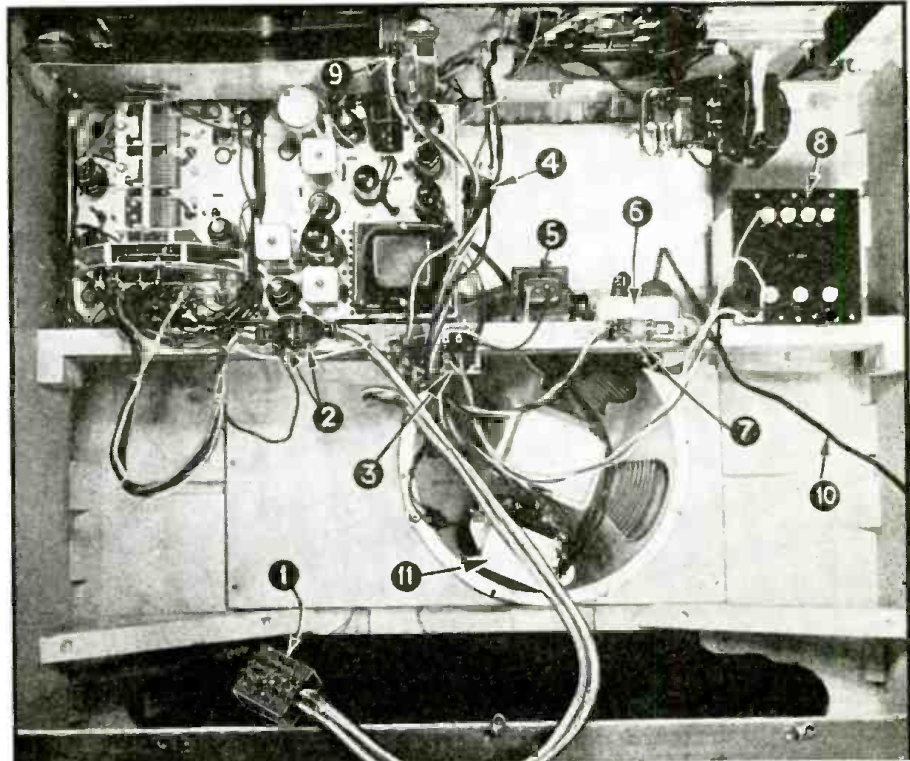

Fig. E. You are now looking into the master radio console cabinet from the rear. The chassis is at the left, the large *triple-cone speaker* in the lower-center and the automatic phonograph motor, upper-right. All the other units are the components which are added in order to adapt the receiver to the built-in radio system. The numbers identifying the various units correspond with those shown in the wiring diagram of Fig. 5. Note the 2 heavy shielded cables (7 color-coded wires in each) running down to the 22-prong "master-inlet" plug. The shields on these plugs are all bonded together with solder at several points. The "on-off" relay is mounted horizontally on the edge of the shelf. The various units are (1) 22-prong plug, (2) 8-prong connector plug, (3) soldering-lug terminal strip (8 lugs), (4) 4-prong plug connector, (5) 6.3-V. pilot-light transformer, (6) base-mounting multiple outlet, (7) on-off relay, (8) impedance-matching autotransformer, (9) double-pole double-throw anti-capacity "set-speaker" switch, (10) master line cord, (11) output transformer mounted on speaker.

put a spot of ink (or any other means of identification) on each end of every wire in one of the cables. Notice in Fig. 5 that all connections to the radio chassis and to components mounted on the tuning panel are made through plug connectors. This is highly desirable since it permits the panel and chassis to be conveniently removed for possible servicing in the future. Any type of connectors having the requisite number of prongs will do.

Be very careful in wiring the Master-Inlet plug. Its 22 closely-spaced prongs tend to confuse one. Look for the 2 polarized prongs and use them as your reference points. These prongs are easily noticed since they are out of line. In Fig. 5 they are shown as black dots.

All this wiring is not intricate, merely time consuming. Perhaps, therefore, it is just as well that we decided to devote an entire instalment to it.

The RCA model U-130 "hi-fi" set is a 12-tube super. with 10 W. output (undistorted). It's diagrammed in Data Sheets 245 and 246 (Feb. '39 issue of *Radio-Craft*). One of the important reasons for selecting this set was that it uses *frequency-compensated* trimmers; thus, no matter which remote panel is operated, the station a button selects is tuned-in "on the nose."

Part IV will complete this series with information and diagrams on the wiring of all the remote speakers, "T" pads and tuning buttons as well as the details on the Armchair Control.



The RCA Victor Model U-130 combination radio and automatic phonograph. This is our master receiver.

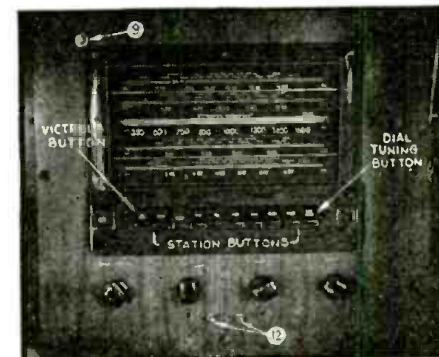

Fig. F. The tuning panel of the master radio receiver. Numbers 9 and 12 point respectively to the "set-system" switch and the "on-off" buttons.

THE PIPELESS ORGAN!

Here's an electronic musical instrument, conforming with standards of the American Guild of Organists, said to look, play and sound just like a pipe organ.

PART II

VICTOR I. ZUCK

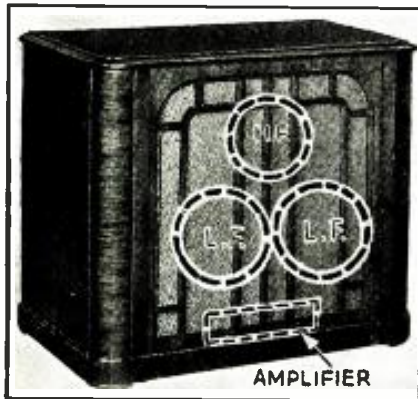

BOOSTER TONE CHAMBER

Fig. C. The Booster Tone Chamber is used wherever greater power is wanted (in churches, etc.). A 30-watt amplifier is built-in with the 1 high-frequency and 2 low-frequency loudspeakers.

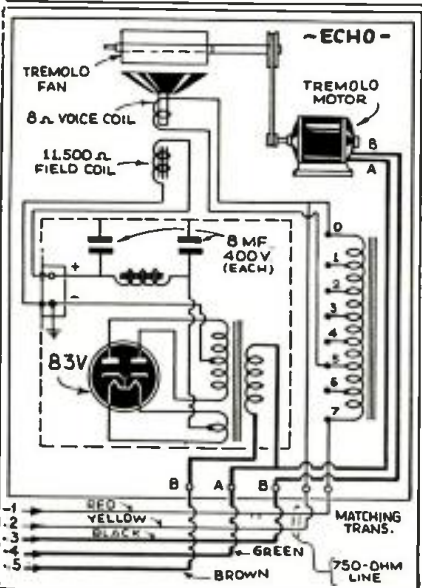
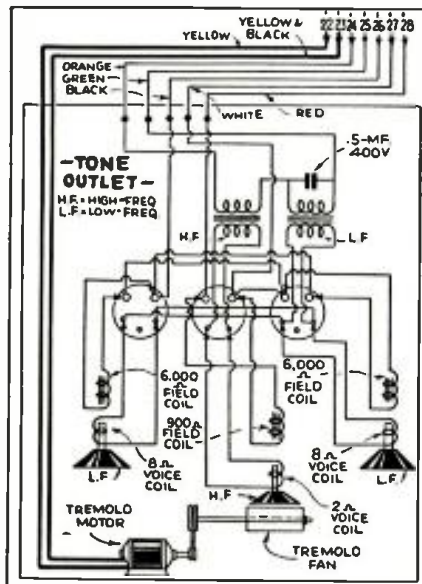

LAST month we told how the Orgatron—the new 8-tube pipeless (electronic) organ—produces tones so closely simulating those of the pipe organ as to seemingly leave nothing to be desired. (This new money-maker is being placed right in the lap of radio Servicemen; progressive members of the profession will be the ones to snap up the big-pay orders. —Editor)

Built in strict conformity with the standards of the American Guild of Organists, and the Royal College of Organists, this masterpiece of Electronic Science, as we shall see, is extremely flexible in its adaptability; an add-on 3-speaker Booster Tone Chamber affords greater power output (the "regular" tone chamber has only the 3 speakers), 1-speaker Echo Organ unit supplies echo and reverberation, and a Cathedral Chimes unit puts a belfry at your command. A motor-driven fan creates desired degrees of tremolo.

Speaking in greater detail, accessories available for this organ are additional tone chambers to double, triple or quadruple the volume. A smaller tone chamber has been designed to produce an echo (see Fig. D), processional or antiphonal effect, depending upon the remote placement of this unit. Chimes (see Fig. E) of the conventional design can also be installed on this organ and operated from the Great manual, per-

mitting chimes and the Great manual tonalities to be played independently or simultaneously.

The Echo Organ, Fig. D, is connected to the Orgatron in a manner allowing it to be played independently or simultaneously with the Orgatron's main tri-speaker Tone Chamber. The energy for the single-speaker Echo Organ is supplied through the main amplifying system in the Orgatron console. The small electrical unit shown at the bottom of the speaker in Fig. 2 is for field excitation of the Echo speaker. The Echo Organ may not only be called an "echo" organ, but an Antiphonal or Processional organ, depending upon the location of this unit. When used as an Echo Organ, it should be located far enough away from the console to produce the effect of music coming from a distance.

In many instances a very delightful effect is obtained by placing the unit in a hard-walled empty room or closet, the door being left slightly ajar. It is advisable to remove all sound absorbing materials in an installation of this kind. A very small chamber or niche in a wall or around a partition with the door left open will in many instances make an ideal location.

When used as a Processional Organ, it is, of course, to be located in a hallway adjacent to the choir, for rendering this particular effect; likewise

(Continued on page 620)

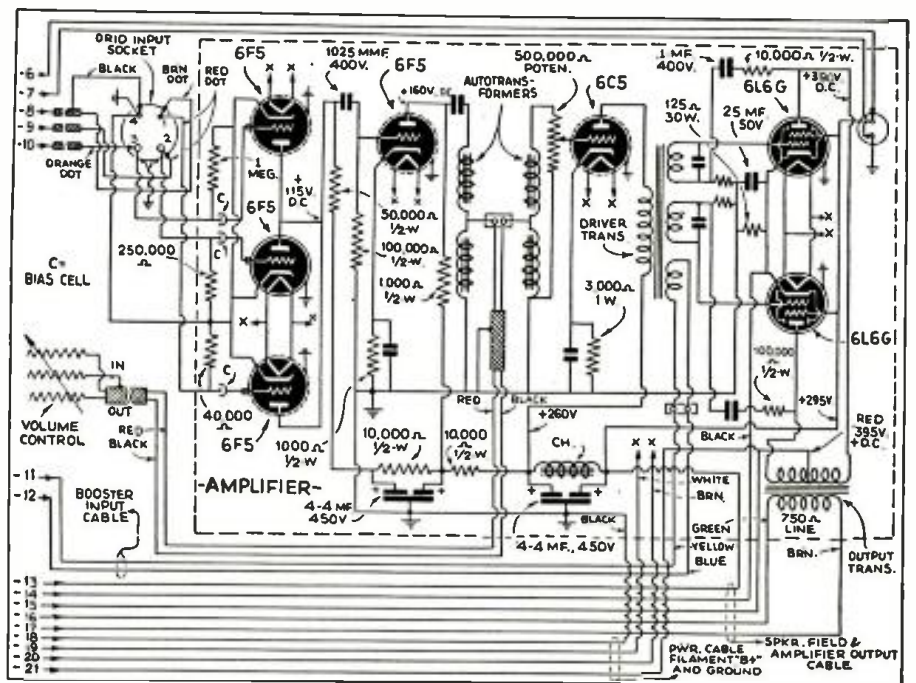

The diagrams on this page connect to the master diagram on the facing page in accordance with the numbering and lettering of the various leads. This method of presentation was adopted in order to simplify analysis of the circuit elements for Servicemen. For you—and you—Mr. Serviceman, will soon be called upon to install and service electronic music instruments of this type. Note that all available data appear in the diagrams.

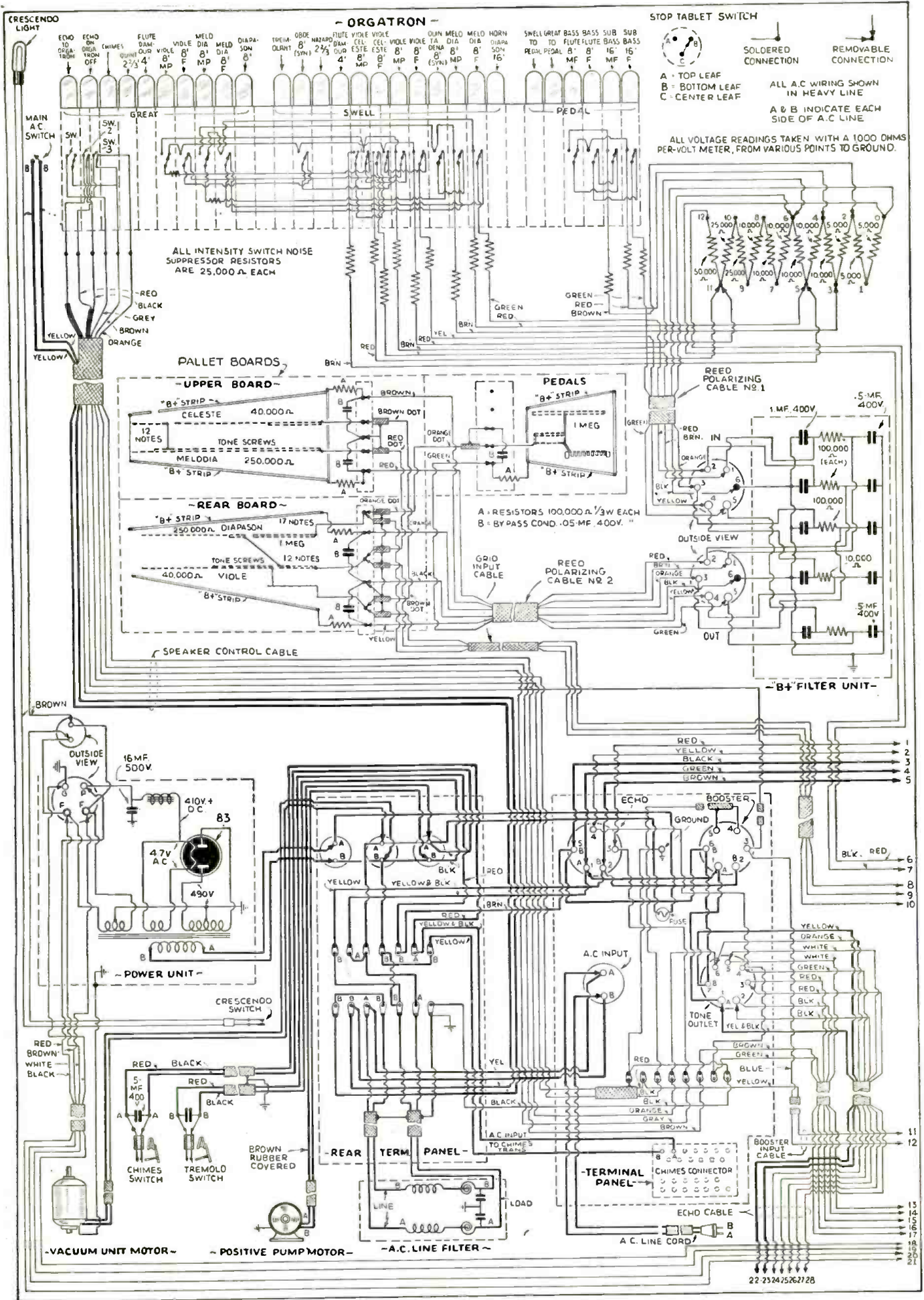

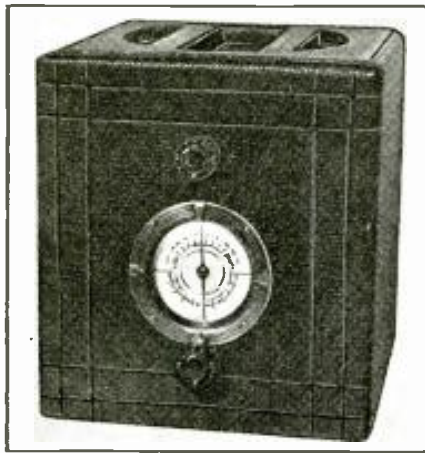

Fig. A
View of the completed 3-tube A.C. superheterodyne receiver. Note that the speaker grille is on top of the case. The top knob is volume.

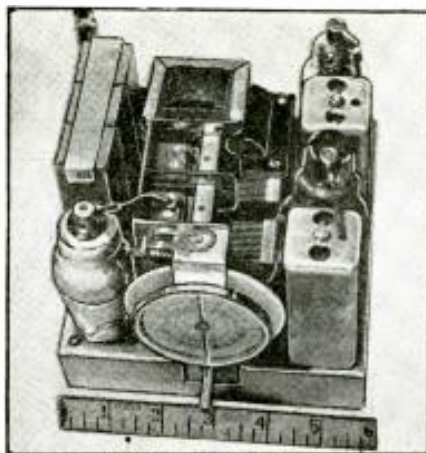

Fig. B
View of the compact chassis. The entire width is only 6 ins. The rectifier tube is combined with the output tube in one envelope, a 12A7.

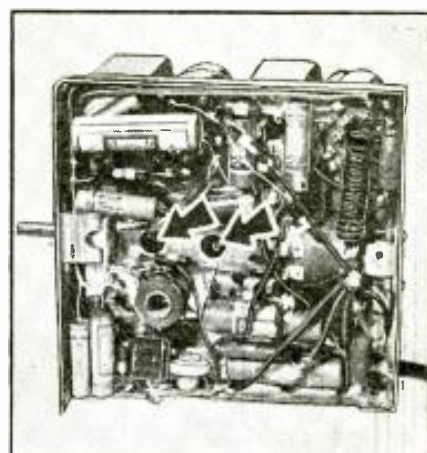

Fig. C
Underside view of the chassis showing locations of parts. The arrows point to the holes in the chassis for adjusting the trimmers.

An Easily-Built 3-Tube Midget

"This radio set has been in daily operation for 3 months, from ½ hour to . . . By and large, this receiver was a very satisfactory construction project for the pleasure of the work but also for the permanent source of entertainment

T. C. ELTON

COMPLYING with an urge, probably common to many other constructors, to build something different, the author worked out a 3-tube A.C. superheterodyne receiver which accomplishes splendid reception, for so few tubes. Stations from the West Coast, such as KNX, are readily received after midnight, here in Pittsburgh. Only one local station provides a strong enough signal to be audible at 20 kilocycles off resonance, and the full audio output, a trifle over 2 watts, has been realized from several of the high power, clear channel stations in the eastern part of the country.

Although the set might be built smaller, it is still well within "midget" dimensions, the chassis base being 6 inches wide by 6¼ inches long by 1¼ inches high. All the materials used, except the base and power transformer, are available at radio supply dealers.

The base was formed from a 7 x 10 inch aluminum panel. The transformer and dial cutouts were chiseled from the trimmed sheet before bending the side and end flanges. Figure 2 shows the layout of the chassis with all specifications. The measurements, locating the 2 cutouts, are given with all the rest of the chassis layout dimensions. Small holes were drilled and socket openings punched after the chassis was formed in order to avoid shifting of reference points which might have occurred during the bending. In Fig. 2, the diameter of all holes is indicated by a number followed by the letter D, except for small mounting bolt holes which were all drilled 9/64-inch in diameter. The exact location of feed-through holes for the several wires which had to go through the chassis have not been given because it is possible that the size of the parts may not be duplicated nor the sequence of wiring. Two holes were drilled through the chassis under the tuning condenser so that its trimmers could be adjusted. They can be seen near the center of the chassis in Fig. C. The corners of the chassis were soldered with special aluminum solder and the rigidity imparted by this operation was found worthwhile.

The assembled chassis is shown in Fig. B. On the left, in front is the 6A7, behind which is the group of 3 filter condensers and the cable hole. Down the center of the chassis, can be seen the dial, tuning condenser, 1st filter choke and the power transformer. The right-hand side supplies space for the 1st I.F. transformer, 6F7, 2nd I.F. transformer, and finally the 12A7.

Power transformers, with 12-volt heater windings, are not common enough to be obtained everywhere. So it was necessary to alter a suitable transformer to meet the need presented by this group of tubes. See parts list for specifications of the transformer used by author. It had a core cross-section of nearly 1 sq. in. and as a result its 5-volt winding was made with 28 turns of wire. If 28 turns of wire gave 5 volts it was reasoned that 65 turns would give the needed 11½ volts to operate the 12A7, the 14-volt pilot lamp and the series-operated 6A7 and 6F7. The current drained by this grouping of tubes is 0.7-ampere. Number 20 wire is large enough to carry this current. The original heater windings were removed and in their place was wound the new low-potential secondary. The transformer was re-assembled, the stack clamping bolts drawn up tightly to remove vibration, tested and mounted on the chassis.

The lateral-wound R.F. and oscillator coils were mounted near the 6A7 socket on the underside of the chassis, and are shown in the lower-left corner of Fig. C. The oscillator coil is the light colored one on the left flange of the chassis. The R.F. inductor is just under the trimmer adjustment holes and mounted with its winding axis perpendicular to that of the oscillator coil.

The filter chokes for this machine may present some problems, such as, mounting and proper resistance. Choke Ch.1 was fastened to the tuning condenser by bending the mounting lugs of the choke to grip the frame of the tuning condenser and then soldering it in place. This part may be seen

in Fig. B. Although Ch.1 is a common enough unit some trouble may be encountered in getting one with values as given in the parts list. A midget output transformer that was intended to couple push-pull pentodes to a speaker was found to have 1,000 ohms and the requisite inductance. The secondary leads and the center-tap of the primary were snipped off and the unit mounted on the frame of the speaker by soldering the mounting lugs of the choke to the speaker. Choke Ch.2 can be seen in the upper-right-hand corner of the cabinet, in Fig. D.

Because of the high level of audio output, a dynamic speaker was apparently advisable but, inasmuch as the total direct current available amounted to only 8.4 watts, it was not possible to properly energize the field pot. of any known speaker and have enough current left to run the machine. This is the reason for the use of the more expensive permanent magnet type of dynamic.

When it had been determined that the receiver was correctly wired, the lining-up of the various high-frequency circuits was undertaken. The R.F. and oscillator coils had been chosen to provide, in conjunction with the proper cut plate type of tuning condenser, signals at the input to the intermediate frequency amplifier of 465 kilocycles. So, the I.F. transformers were resonated at 465 kilocycles. With the test oscillator supplying 1,500 kilocycles to the No. 4 grid of the 6A7, the tuning condenser was properly set, with respect to the dial and the alignment frequency, and the oscillator trimmer adjusted until the test signal appeared at its optimum in the output. The No. 4 grid was then connected to the proper part of the circuit and the R.F. section trimmer adjusted until a local 1,500 kilocycle station was received at its best. The tuning condenser was fully meshed and the circuit alignment checked at the lowest receivable frequency and was found to be approximately correct; by bending the oscillator-section plates the circuits were made to track properly over the entire tuning range.



Fig. D
View looking inside the cabinet. Note how compactly everything is mounted and how snugly the speaker fits in among the other components.

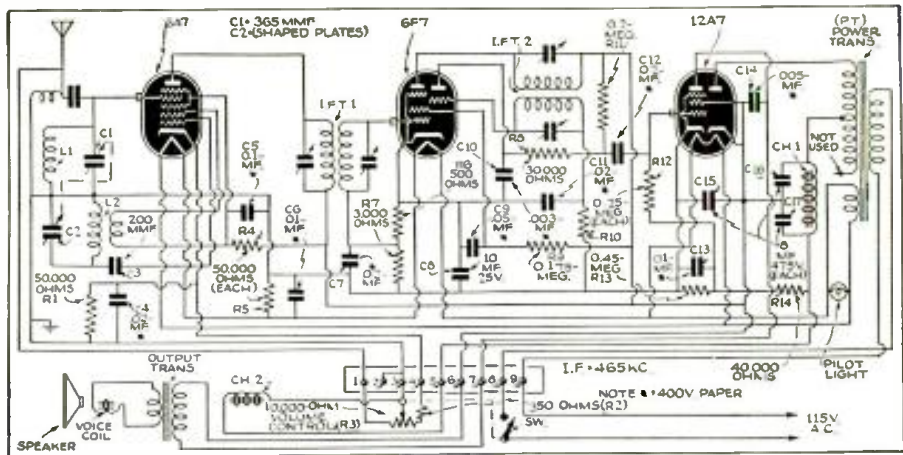

Fig. 1
Complete schematic diagram of the 3-tube A.C. superheterodyne receiver. The set is designed exclusively for the broadcast band. This circuit affords splendid reception even to the extent of DX-ing Californian stations from Pittsburgh, Pa.

Broadcast Superhet. Set!

6 hours at a time, without any breakdowns or weakening of parts or tubes and is sincerely recommended to all who would build such a radio, not only thereby provided." Coast-to-coast reception has been achieved with this A.C. set.

The circuit is not very critical of tube constants but the 12A7's of various manufacturers do not all possess the same characteristics. A certain make of tube was found to produce hum because there was no electron shield between the rectifier and pentode sections of the tube. In other respects it was applicable to this machine even though it had a slightly higher rectifier plate resistance and a lower pentode amplification factor than the make of tube named in the parts list. Both makes showed better than 50 million ohms hot heater-to-cathode resistance. This radio set has been in daily operation for 3 months, from ½ to 6 hours at a time, without any breakdowns or weakening of parts or tubes.

In Fig. A, the completed receiver is seen to possess a rather attractive appearance. The case was made of 3-ply fir, 7% inches deep by 7% inches wide and 8% inches high. The outside of the box is covered with black leatherette. The volume control is adjusted by the knob above the tuning dial. This machine is well suited to almost any number of cabinet applications including metal cases, and since the chassis is at ground potential there is scant possibility of receiving any shock from such cases.

By and large, this receiver was a very satisfactory construction project and is sincerely recommended to all who would build such a radio, not only for the pleasure of the work but also for the permanent source of entertainment thereby provided.

RESISTORS

- Two I.R.C., 50,000 ohms, ¼-W., R1, R5;
- One I.R.C., 350 ohms, ¼-W., R2;
- One I.R.C., 50,000 ohms, 1 W., R4;
- One I.R.C., 500 ohms, ¼-W., R6;
- One I.R.C., 3,000 ohms, ¼-W., R7;
- One I.R.C., 30,000 ohms, ¼-W., R8;
- One I.R.C., 0.175-meg., ¼-W., R9;
- Two I.R.C., 0.25-meg., ¼-W., R10, R12;
- One I.R.C., 0.2-meg., ¼-W., R11;
- One I.R.C., 0.45-meg., ¼-W., R13;
- One I.R.C., 40,000 ohms, ¼-W., R14;
- One wire-wound volume control and switch, 10,000 ohms, R3;

LIST OF PARTS

MORE NEW TUBES!

(In May Radio-Craft)

Read about the new stubby television tube which, because of its unusually short length, makes possible more compact television sets. A new high permeance R.F. power amplifier and modulator affords greater output for a given input, in transmitters. A permatron—an entirely new type of tube—has been announced for control applications; either grid or magnetic control of the tube's operation is available. Improved television tubes afford black-and-white images and high-efficiency operation. New acorn tubes of low-drain (50 ma. and 100 ma.), direct-heater type make possible extremely small transmitters and receivers! And those local tubes—be sure to look for the characteristics data on the new ones in this series so far produced.

CONDENSERS

- One Cornell-Dubilier mica, 200 mmf., C3;
- Four Cornell-Dubilier paper, 0.02-mf., 400 V., C4, C7, C11, C12;
- Two Cornell-Dubilier paper, 0.1-mf., 400 V., C5, C13;
- One Cornell-Dubilier paper, 0.01-mf., 400 V., C6;
- One Cornell-Dubilier electrolytic, 10 mf., 25 V., C8;
- One Cornell-Dubilier paper, 0.05-mf., 400 V., C9;
- One Cornell-Dubilier paper, 0.003-mf., 400 V., C10;
- One Cornell-Dubilier paper, 0.005-mf., 400 V., 0.005-mf., C14;
- Three Cornell-Dubilier electrolytic, 8 mf., 475 V., C15, C16, C17;
- One Meissner antenna coil (1,500 to 550 kc.);
- One Meissner broadcast oscillator coil (to work with L1 in a 465 kc. super.), L2;
- One 2-gang tuning condenser with cut-plate oscillator section to match L2, 365 mmf., C1, C2;
- Two Meissner standard double-tuned I.F. transformers, 465 kc., I.F.T.1, I.F.T.2;
- One filter choke, 10 hy., 40 ma., 300 ohms, Ch.1;

- One filter choke, 15 hy., 30 ma., 1,000 ohms, Ch.2;
- One power transformer (see text) Pri., 115 V. 60 cycle; Sec. 1, 650 V., 40 ma., C.-T.; Sec. 2, 2.5 V., 3.75 A., C.-T.; Sec. 3, 5 B., 2 A., P.T.;
- One Wright-DeCoster speaker and output transformer, model 700 Nokoil, SP, OPT;
- One miniature Mazda lamp, 14 V., PL;
- Three 7-prong wafer sockets, 1.5-in. mounting centers;
- One aluminum panel for chassis, 7 x 10 ins.;
- One cabinet;
- One dial, escutcheon and lamp socket;
- Two control knobs;
- Two tube shields for ST-12 bulbs;
- One 7-contact terminal strip;
- One Raytheon 6A7 tube;
- One Raytheon 6F7 tube;
- One Raytheon 12A7 tube.

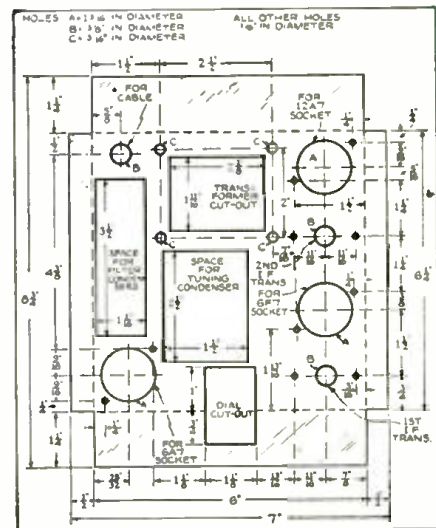

Fig. 2
Complete specifications for making and drilling the chassis for the 3-tube superheterodyne broadcast receiver.

COMPLETE STEP-BY-STEP

What is Dynamic Servicing?—See how many of your associates in the service field increase your earning power by speeding your radio service work. This, Part IV, con-

PART IV

Section 5

ALIGNMENT OF A.F.C. CIRCUITS

THIS operation should be performed immediately following the alignment of the I.F. stages, and with the frequency setting of the Test Generator undisturbed.

CONNECTIONS TO THE DISCRIMINATOR CIRCUIT

In circuits where the discriminator diode also supplies the A.V.C. and A.F. circuits (see Fig. 4G, Part III), disconnect the condenser "C" from the "high" (high-voltage) side of the diode to ground. Connect the vertical lead from the oscilloscope to the point marked "F." and open the A.F.C. switch.

Figures 5A and 5B show the correct and incorrect patterns for alignment. Adjust the padder "T" until the crossing of the 2 patterns is exactly in line with the ends of the curves, as indicated by the dotted line in Fig. 5A.

If the ends of the curves do not come together as indicated in Figs. 5A and 5B, advance the setting of SWEEP WIDTH KC. on the oscilloscope.

This completes the alignment of the discriminator, following which the vertical connection should be removed and the condenser "C" reconnected.

Receivers having a separate diode in the discriminator circuit are tested in the same manner, but the primary trimmer of the discriminator will also have to be adjusted. This will affect the amplitude of the pattern of Figs. 5A and 5B, which should be set for maximum amplitude.

Section 6

ALIGNMENT OF THE LOW-FREQUENCY PADDER

By the following method, rocking the variable condenser while adjusting the low-frequency oscillator padder is eliminated and a more accurate alignment results.

NOTE: Use of the 1,500 kc. and 600 kc. frequencies in the following directions is entirely illustrative. If the manufacturer's data sheet specifies other frequencies, such as 1,550 kc. and 575, use them. This information also applies to the shortwave bands. Simply substitute the manufacturer's stated frequencies.

NOTE—The 'scope patterns at first glance may seem to be upside-down—the "feet," for instance, are shown in the air—but this is OK. Reason is that the pattern voltages are taken from the detector plate; taken from the next tube's plate, the patterns would be inverted from those shown on pages 540 and 541, last month, for example.

1,500 KC. ALIGNMENT

Leave the VERTICAL connections of the oscilloscope and the settings of the Linear Sweep controls just as they were for alignment of the I.F. amplifier. (See Part III.)

Remove the R.F. input lead from the R.F. OUT. jack of the oscilloscope and plug it into the output of the Signal Generator. Set the Generator to 1,500 kc. and turn on the 400-cycle modulation.

Connect the R.F. input lead from the Signal Generator to the antenna and ground of the receiver through a DUMMY ANTENNA.

NOTE: Most manufacturers specify the correct size dummy antenna to be used on the various bands. In the absence of such data use a 200 mmf. condenser for the broadcast band, or a 400-ohm resistor for shortwave bands. Either should be connected between the high side of the output lead and the antenna post at the receiver.

TRIMMING

Temporarily, set the HORIZONTAL control of the oscilloscope at zero and use the amplitude of the vertical trace on the screen as a tuning indicator.

With as small an input from the Signal Generator as is practical, trim the condensers on the T.R.F. condenser sections, and the high-frequency padder of the oscillator section.

This is the standard operation, except for the use of the oscilloscope as an output indicator.

SETTINGS FOR THE 600 KC. TRIM

Disconnect from the Signal Generator the R.F. input lead to the receiver and reconnect to the R.F. OUT. jack on the oscilloscope.

Turn off the 400-cycle modulation in the Signal Generator.

Make all settings just as for alignment of the I.F. transformers, except that the R.F. input is now to the antenna and ground posts of the receiver through the dummy antenna rather than to the I.F. grid circuit.

Set the Signal Generator for 600 kc. output from the oscilloscope (the Clough-Brongle Model 127 Graphoscope). See Part III, sub-head "Setting the Generator to the Desired Test Frequency."

Turn the receiver dial to the vicinity of 600 kc. and a selectivity pattern will be seen on the screen as in Fig. 4K (Part III). It will very likely be out of resonance, as indicated by the failure of the 2 curves to coincide.

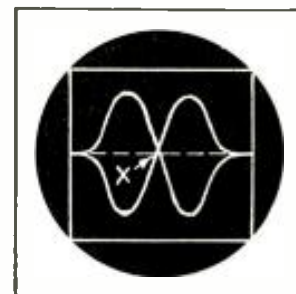

Fig. 5A. Correct A.F.C. alignment. Intersection "X" is in line with ends of curves.

ALIGNING AT 600 KC.

With one hand on the receiver tuning knob and the other on the alignment tool, turn the low-frequency oscillator pad to bring the pattern to the greatest possible height and at the same time slowly turn the receiver dial to make the 2 peaks coincide, as in Figs. 4J or 4L (Part III).

Correct alignment is had when the 2 traces or the peaks of the traces coincide, and the pattern has the greatest possible amplitude.

DIAL TRACKING WITH ANTI-CAPACITY DEMODULATOR

Connect an anti-capacity demodulator to the oscilloscope in the manner described in Part III under the sub-heads "Using An Anti-Capacity Demodulator" and "Connecting the Demodulator."

Remove the grid cap from the 1st-detector, and connect it to the blue lead of the demodulator (C-D Model 147). Clip the braided lead to the chassis.

Connect the Signal Generator to the antenna ground post through a suitable dummy antenna. Turn on the 400-cycle modulation.

Turn the HORIZONTAL amplifier control of the oscilloscope to "0" and advance the VERTICAL control sufficiently to get a vertical trace on the screen when the input circuits of the receiver are tuned to resonance with the Signal Generator output.

By adjusting the Signal Generator to various frequencies throughout the band, and tuning the receiver to resonance with each frequency, using the amplitude of the vertical trace as a measure, the dial may be completely checked, independently of the oscillator and the I.F. circuits.

This test set-up is also useful in correcting faults in the R.F. circuits, and getting them to align when the set oscillator is "dead."

DYNAMIC SERVICING

can answer this question! Then read this article and see how this test procedure continues the description of how to set up cathode-ray test equipment for Dynamic analysis.

KENDALL CLOUGH

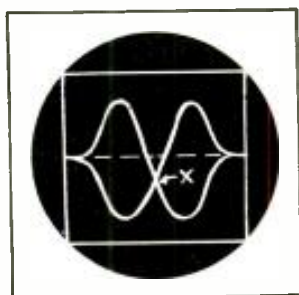

Fig. 5B. Incorrect A.F.C. alignment. Intersection "X" is below line through ends of curves.

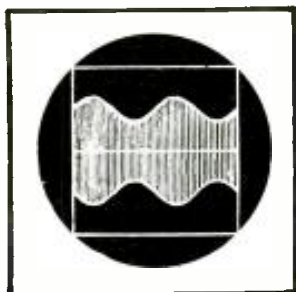

Fig. 8A. Output of R.F. oscillator with sine wave modulation.

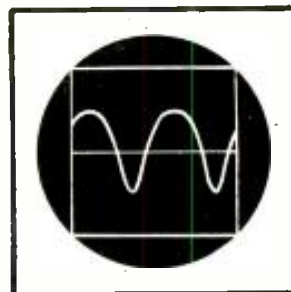

Fig. 8B. Distortion due to defective A.V.C.

Section 7

ALIGNMENT OF REJECTOR CIRCUITS

Many receivers employ a tuned circuit in the antenna or ground circuit for rejecting any signal of the same frequency as that of the I.F. amplifier. Checking such circuits is most conveniently done after completing the I.F. alignment, due to the similar setting of the instrument controls.

SETTING UP THE TEST

Connect the oscilloscope to the 2nd-detector output just as for I.F. alignment. Leave the controls of the oscilloscope just as set for I.F. alignment, but advance the VERTICAL control to "10."

Set the Signal Generator Frequency and output from the oscilloscope just as for alignment of the I.F. circuits, but advance the Signal Generator output all the way, and turn the R.F. MULTIPLIER dial of the oscilloscope to 100. Tune the receiver to a low frequency, and the selectivity pattern of the receiver will show on the screen. Now connect the R.F. lead (from the Model 127 R.F. OUT. jack) to the antenna-ground posts of the receiver, through a dummy antenna.

TRIMMING THE REJECTOR CIRCUIT

Turning the trimmer of the rejector circuit will result in a reduction in height of the selectivity pattern when properly tuned. In some receivers it will have the added effect of flattening the nose of the selectivity pattern. Correct alignment is indicated when the pattern has minimum amplitude and the flattening, if any, is symmetrical.

Section 8

TESTING THE A.V.C. CIRCUIT

The following test is the best assurance possible that the A.V.C. circuits are in the best possible working order. No need to waste time making resistance analyses until you are sure that there is trouble in the A.V.C. circuit.

TESTING THE SIGNAL GENERATOR

The Signal Generator used for the A.V.C. test must have sinusoidal modulation, and must therefore be tested, unless its waveform has been previously checked. The test needs to be made only once, of course. (Clough-Brengle Models OCA, OMA, OCX, 110 and 199 have this characteristic.)

Turn on the audio modulation in the Generator, set the frequency to 100 kc. and turn the attenuator all the way up. Connect the output of the Generator to the VERT. posts of the oscilloscope. Turn the CONTROL to INTERNAL and the SWEEP to LINEAR.

Adjust the FREQUENCY and VERNIER dials so that a stationary pattern similar to Fig. 8A is seen on the screen, and lock the pattern with the SYNC. knob.

The form of the pattern must be smoothly sinusoidal, as in Fig. 8A, otherwise the Generator is unsuitable for A.V.C. or other distortion testing.

CONNECTIONS FOR THE A.V.C. TEST

Leave the VERT. posts of the oscilloscope connected to the 2nd-detector output, just as for the I.F. alignment and the 600 kc. alignment.

Connect the Signal Generator to the receiver through a dummy antenna, and tune the receiver to the oscillator at any broadcast frequency where there is no local broadcast interference.

Give the receiver a small input from the Signal Generator and set the linear sweep circuits as directed above. A pattern of the rectified generator modulation will be seen on the screen. (Single line, not a solid pattern.)

Recheck carefully the tuning of the receiver to the Signal Generator, using the lowest practical output from the attenuator, and watching the pattern for maximum amplitude.

Gradually increase the output from the Generator. The pattern will grow in size, rapidly at first until the A.V.C.

action takes hold, then less rapidly. As the pattern enlarges, hold it on the screen by reducing the VERTICAL control.

If the A.V.C. circuits are functioning properly, the pattern will maintain its sinusoidal shape right up to the maximum output of the Generator. See Fig. 1D (Part I). If any defect exists, such as a leaky or shorted A.V.C. condenser, or an open A.V.C. resistor, distortion will appear as in Fig. 8B.

The actual defect may then be quickly located by a resistance analysis of the A.V.C. circuit portion.

Section 9

HUM CHECKING

CONNECTIONS

Connect the VERT. binding posts of the oscilloscope across the voice coil of the speaker. Make no connections to the input of the audio amplifier, and turn the audio volume control to zero.

SETTING OF THE OSCILLOSCOPE CONTROLS

The hum frequency will be definitely related to the line frequency, so a sweep frequency of 30 per second is recommended. Instructions for obtaining this are given in Part II under the subtitle "Setting the Oscilloscope Controls for Filter Checking."

OBSERVATION OF THE HUM PATTERN

In general, the amplitude of the hum pattern should not exceed .2 divisions on the screen per ohm voice coil impedance, with the VERTICAL amplifier control on the oscilloscope at "10." For example, with a 10-ohm voice coil, no more than 10x.2, or 2 divisions amplitude on the screen can be tolerated, without risking customer dissatisfaction.

Hum patterns are quite complex and correspondingly numerous. In viewing them, the important thing is to recognize
(Continued on page 633)

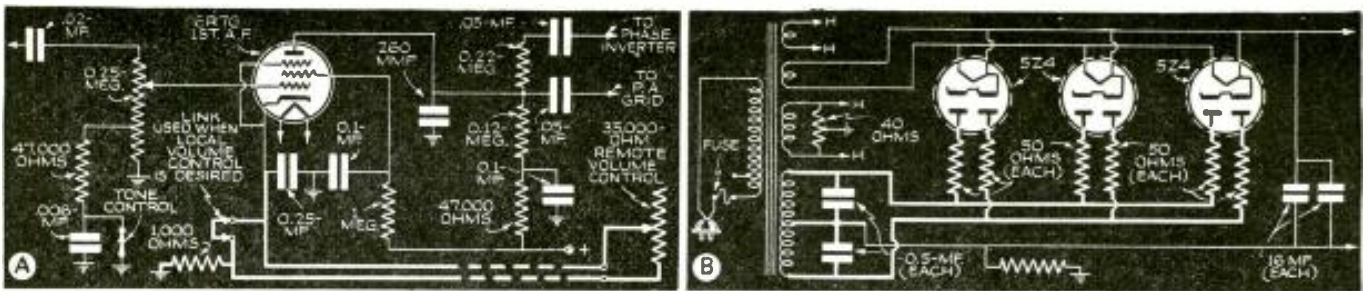

Fig. 1. New circuit features of (A) Stewart-Warner Chassis 91, 98 and 910 Series. (B) G.E. Models A205 and A208 Series. The heavy lines accentuate the features.

NEW CIRCUITS IN MODERN RADIO RECEIVERS

The details of the modern radio receiver circuits that make them "different" from previous designs are illustrated and described each month by a well-known technician.

F. L. SPRAYBERRY

NUMBER 19

(1) NEW REMOTE VOLUME CONTROL

Stewart-Warner Models 91-111, 98-111 and 910-111. A volume control independent of the regular control with the receiver unit, carrying no signal and permitting practically any cable length is used on these receivers.

With reference to Fig. 1A, it will be observed that the cathode of the 1st audio amplifier is connected through a 35,000-ohm rheostat in the remote unit by means of 2 wires of the remote cable. The other wires in the cable (not shown) are for the various pushbuttons for tuning control.

A remote cut-off type pentode 6R7G is used for the 1st audio, so that volume can be controlled by the cathode voltage method. Any signal voltage at the cathode is bypassed to ground through the 0.25-mf. condenser. An increase of the cathode resistance at the remote unit will make the cathode more positive and hence, the bias and signal at the tube will be reduced. Thus, the volume can be raised to a point set by the volume control in the chassis or lowered to any lower value. The signal is so small at the grid of this tube that no appreciable distortion is introduced by disproportional grid-voltage—plate-voltage effects.

When local volume control is used, a link is attached across the remote volume control leads so that its setting will no longer have any effect on the volume.

(2) POWER SUPPLY USES 3 RECTIFIERS IN PARALLEL

General Electric Model A-205, A-205E, A-208 and A-208E. The very considerable D.C. power required, principally by the 6-tube output stage of this receiver, makes it necessary to use 3 type 5Z4 rectifiers in the power supply.

One plate of each rectifier is connected to one side of the high-voltage winding through a 50-ohm resistor, while the other plates are similarly connected to the other side of the high-voltage winding. Figure 1B shows the circuit used.

The resistors commonly used when either rectifier or amplifiers are operated in parallel, serve to equalize their operation. Without these resistors, any tendency for one tube to draw more current than another will be magnified by the operation of the tubes. As one draws more current, its own voltage will drop and lower the voltage of the other tube with it. The other tube will then be even less capable of drawing its share of the current. When much of this voltage drop can be lost across a resistor, one tube cannot affect the others in this way.

(3) NEW-TYPE DUAL VOLUME CONTROL

Sentinel Model 11A. Control of the signal in the high-frequency stages independent of the A.V.C. in addition to the

usual 2nd-detector output control of the A.F. is used in this circuit.

We observe from Fig. 2A that a 2,500-ohm variable resistor is in series with the cathodes of the R.F. and I.F. tubes. Ordinarily there is no manual control of the R.F. or I.F. system, the control being entirely determined by the incoming signal. With this dual control especially in connection with signals of medium field strength, the sensitivity of the set is varied in proportion to the volume.

As the volume is increased, the sensitivity is increased and the A.V.C. action is most complete. However, as the volume is reduced, reduction of the sensitivity, allowing in less signal permits less A.V.C. action, and places greater responsibility on the sensitivity control in the cathode circuit. The chief advantage is the minimizing of cross-modulation.

(4) NEW LOCATION IN CIRCUIT FOR INTERFERENCE FILTER

Wells-Gardner & Co. Model A14. A series resonant circuit tuned to the I.F. is placed across the plate load circuit to minimize interference with signals of the same frequency.

With reference to Fig. 2B, it may be seen that any signal component of the frequency to which L and C are tuned will be effective. (Continued on page 617)

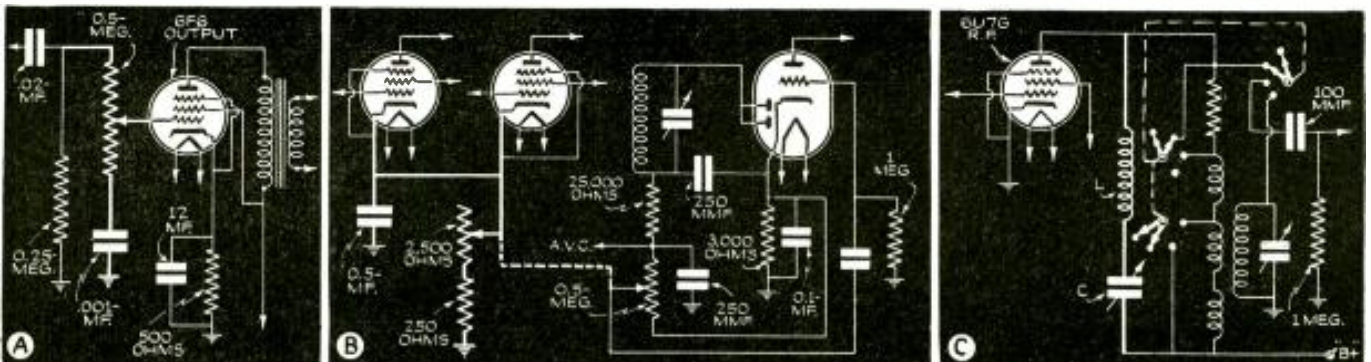

Fig. 1. New circuit details of (A) Sentinel Model 14A, (B) Wells-Gardner Model A14 and (C) Westinghouse Models WR-212 and WR-312 Series. The heavy lines accentuate the features.

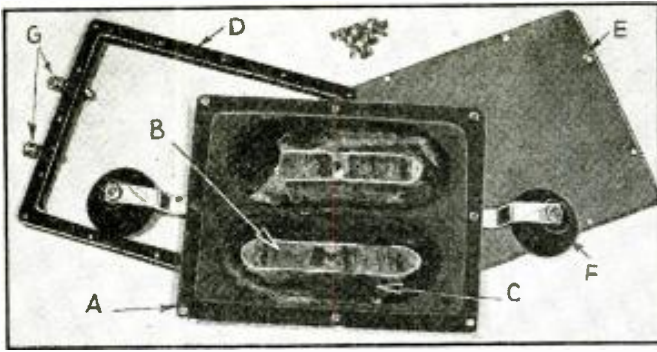

Fig. A. Exploded view of the pickup; A, brass plate; B, saw blade core; C, winding; D, frame; E, fibre back; F, suction cup mounts; G, terminal posts. Note the insulating compound.

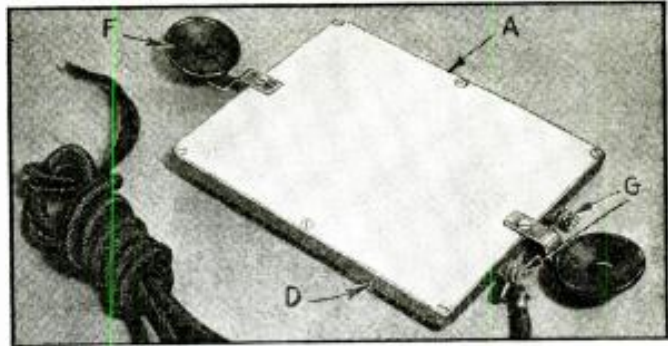

Fig. B. The electromagnetic pickup, when placed beneath the steel strings of a guitar, will permit amplification of the music to any degree. The letters correspond with those of Fig. A.

A Home-Made STRING-MUSIC PICKUP

Want to play that guitar (mandolin, etc.) so sweet and low no one else can hear you? Then build this simple magnetic pickup, connect it to an amplifier, and listen to your playing through headphones. Or rattle the window panes, at that dance next month, by using a loudspeaker!

KENDALL FORD

ONE of the novel and interesting developments of sound amplification is an electro pickup that increases the volume of metal-stringed musical instruments tremendously. When used with a guitar and a suitable amplifier it is possible for a performer to fill with music, an auditorium seating several thousand people.

Heretofore, the cost of reproducing an electro pickup was almost prohibitive but now one may be built solely from salvaged material that will amaze the listener with its clarity of tone. The only materials required are some old hacksaw blades, a discarded ignition coil, an old radio panel, a few machine screws, and some pieces of cardboard.

Break the hacksaw blades into pieces about 4 inches long, grind off the teeth and shape as shown at Fig. 1A. A hole should be drilled through the center of each piece but before drilling it will be necessary to "anneal" (soften) the spot to be drilled.

ANNEALING

This may be done by a small acetylene flame, or if that is not available, a heating gas flame and a small metal or glass tube to serve as a blowpipe will do the job. Most

garages have acetylene gas on hand for welding purposes and since the job of heating the pieces will take just a few seconds, the cost should be trivial.

Heat the spot to be drilled to a red heat and allow it to cool slowly; try to keep the heated area as small as possible.

Drill a hole in each piece where indicated, and tape together, as shown at Fig. 1B. Before taping together it will be advisable to join the pieces together with a small bolt to line them up. After the pieces are taped together they should be "dressed down" (filed to shape) with a file or emery wheel until all pieces are even at the ends. The taped pieces are to serve as the core and there will be 2 required for the pickup. The holes to be drilled in the core pieces are indicated as 3/16-in., but may be varied if the builder desires to use a different size of rod for the crank on the winding form.

MAGNETIZING

After the core sections are completed, they should be magnetized by wrapping each section with about 50 turns of magnet wire, size No. 18 to 22. Connect this "electromagnet" to a storage battery, as shown at Fig. 1C.

Since it is important to know the polarity of the cores when connecting the coils of the pickup, each end should be marked when it is being magnetized. A small magnetic compass will assist in determining the polarity of the magnetized end, but if one is not available, polarity may be determined by winding the coil and connecting it to the battery as shown at Fig. 1C. Assuming that the current flows from the positive pole of the battery in a clockwise direction around the core, the end toward the observer will be the South pole of the core. (Changing or reversing the connections at the battery will cause the current to circulate in an opposite direction and make the observed end the North pole of the core.)

If the larger sizes of wire are used for magnetizing the core, the coil may heat up rather quickly, but that may be reduced by connecting the coil so that it gets only 4 volts instead of 6, or across 2 cells of the battery instead of 3. At the most it should not be necessary to leave the coil connected to the battery longer than 1 minute. The magnetized cores should have sufficient strength to support their own weight, without the windings, when the North pole of

(Continued on page 624)

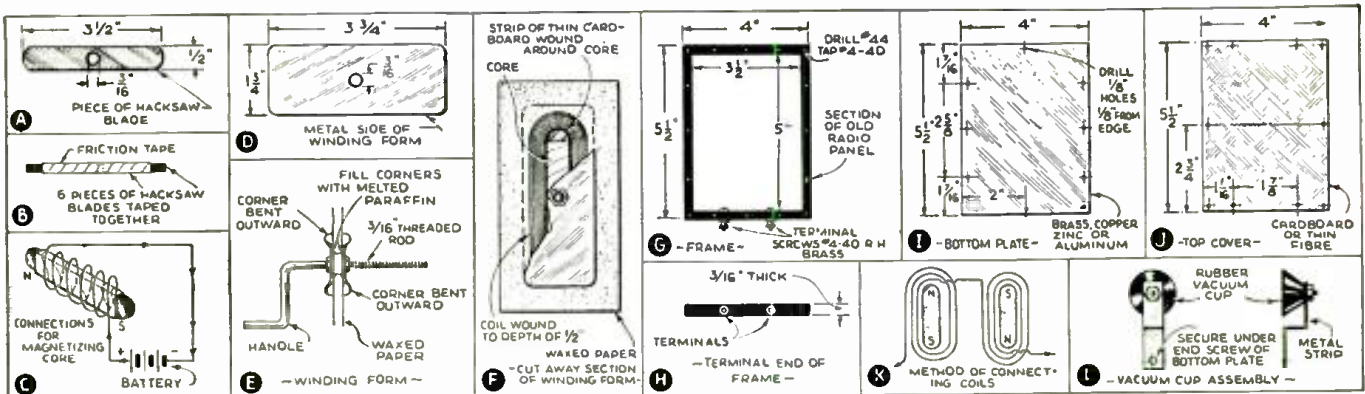

Fig. 1. Complete pictorial presentation of the construction stages of the electromagnetic string-music pickup. See text for details.

SIMPLE TECHNIQUE FOR

It's easy to put life into those old motion pictures you took last year or the mean not only the voices of loved ones but sound-effects as well. The probability but its basic principles as Mr. Tuthill shows may be inexpensively

C. A. TUTHILL

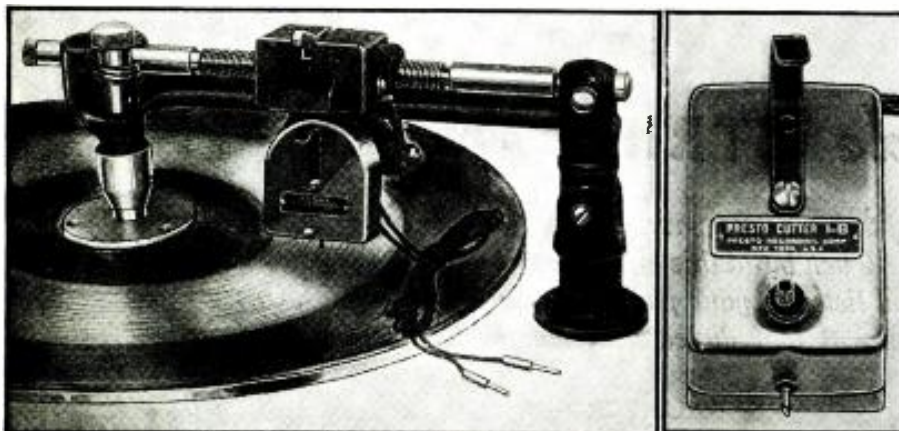

Fig. A. In photo 1 is shown a complete recording head and feeding mechanism. The spindle screw, wormed and geared to the cutting head, assures equi-distant groove cutting. Photo 2 shows a standard electromagnetic cutting head.

IN last month's instalment, we discussed in a general way, the technique for making home talkies;—placement of the mike, sound effects, proper lighting, acoustic considerations, setting-up of props, etc. In this concluding instalment we describe more specifically the recording of sound on both disc and film.

DISC RECORDING

Recording discs unlike film records require constant care and protection. Because of its limited poor spectral quality, we will ignore the rugged *aluminum* record. In contrast the *acetate* or *cellulose* surface, flomed upon an aluminum-base disc, handles frequencies from 50 to 7,000 cycles.

Their glossy face, by no means a hard surface, is prone to abrasion. They should at all times be kept free from any particles of dust or dirt, and from severe heat, even after being recorded and filed away in envelopes. Too, their faces must be held free from any pressure against them, possibly by means of racks.

Otherwise these discs are non-breakable. They are also non-inflammable as a mass, yet, threads cut from the groove during recording are inflammable. The latter therefore should be discarded with attention to this fact.

A "fixing bath" if immediately applied to a completed record will preserve its life. And, though quick-drying, it serves as a lubricant to the reproducing needle. Also it reduces the accumulation of dust and grit which causes surface or needle noise and depreciation through record wear. Various compounds available may be applied with a soft cloth.

TURNTABLE

The prime requisite in disc recording is a sturdy, electrically-driven turntable with a sufficient torque to drive the needle through the resistance offered by the record.

It must be solidly built; must run level and free from speed variation; and lastly, must be free from vibration. It should be powered by a 60-cycle synchronous motor such as used to sync the camera. Lengthy recordings of 12 minutes or more require that it be equipped to handle 16-in. discs at a speed of 33 1/3 r.p.m. Otherwise for home use tables operating at 78 r.p.m. will handle 7 1/2 mins. of material on a 16-in. disc. See Table I for comparisons of different sized discs at both speeds.

CUTTER HEAD

The heart of the disc recorder is the *cutter-head* (see Fig. A2). Electrically the principle involved in its operation is the same as that of an electric motor. Each takes electrical energy and converts it into mechanical energy. Alternating current (speech or music) is fed to the coil windings of the cutter. Its armature, to which the stylus is secured, vibrates from one pole to the other in proportion with the currents received.

Since linear cutters are essentially a "constant velocity" unit, a certain condition exists which should be borne in mind. For a given input voltage applied across the speech coils, the amplitude of the wave inscribed on the disc at 500 c.p.s. (cycles-per-second) will be twice as great as that at 1,000 c.p.s., and 4 times the amplitude of the 2,000-cycle tone. Then, the lower the tone, the greater the amplitude. Boiled down, this simply means that, the stylus swings further from side to side while handling lower frequencies and will therefore "cut over" from one groove to another sooner at lower tones than for those farther up the scale.

Therefore after a trial cut we can decide whether our "level" (amplification) is too great or over-modulated by examining the grooves inscribed in the bass register. Whether or not the recorded level is suffi-

ciently over surface noise can best be told by playing-back the trial cut. The proper level is that whose pianissimos sufficiently over-ride surface scratch and whose fortissimos are such as to handle ample volume safely below distortion limits. Save old discs for trial cuts and tests. They are priceless for this purpose. There is likely to be a more evident surface when cutting at 33 1/3 r.p.m. than when cutting at 78 r.p.m.

Any reliable make of the many cutting heads on the market is satisfactory but some care must be extended to retain frequencies above 4,000 c.p.s. Simple things such as a minutely loose sapphire, or loose needle screw, or too long a needle shank extending from the head will wipe off highs entirely. The adjustment of the head to acquire the best angle and pressure, where the stylus contacts the record, can best be determined by test cuts. A good average set-up is depicted in Fig. 4.

A shrill squealing noise will result if the needle is dull or set at an improper angle. A very satisfactory groove depth is 0.003-in. The thread cut from that is about the thickness of a human hair and sometimes must be removed during the recording if it becomes tangled or contrary. If, however, this thread is at first guided to accumulate on the center spindle when cutting from outer to inner circumference, little attention is needed here.

Cuts at 33 1/3 r.p.m. should not be carried closer than 3 1/2 inches from the center of the record. It is in that region of the disc that a rapid loss of highs is felt. Various cutters marketed require peak levels ranging from plus 16 db. to plus 20 db. to normally actuate their stylii. They range in impedance from 15 to 600 ohms so one best suited to your local equipment may be selected.

CUTTER-FEED DEVICE

Some means of feeding mechanism to guide the cutter across the record in a constant spiral, is required which will keep the grooves of the cut equi-distant. (See Fig. A1.) Bracket-mounted overhead lead-screws, wormed and geared to be driven by the spindle at the turntable center, is the most accepted method of cutter feed. Spindle screws may be obtained which will inscribe cuts of from 96 to 120 lines-per-inch. The more lines the longer the record. But, the fewer lines the greater the latitude for volume range. Hence the beginner best start with fewer cuts to the inch.

DISC PLAYBACK

Accurately leveled tables should be used for playback. They will eliminate side-wall wear caused by the off-center drag of the needle riding a slanting table.

Should acetate records be played on an acoustical phonograph, rather than through an electrical pickup, the use of BENT needles will reduce wear caused by the heavier pickup. Good grades of electrical pickups are balanced to exert only a pres-

MAKING HOME TALKIES

ones you plan to take this year by adding Sound. And by Sound we mean the production of professional talkies entails considerable expense and technical skill, but it is easily modified for use by the radio man and amateur movie maker.

PART II (Conclusion)

sure of about 2 ounces upon the disc. Surface noise under this latter condition should remain inaudible through a half-dozen playings. At the first playing there should be a signal-to-noise ratio of about 40 db., if the disc was recorded at a healthy level of say plus 20 db.

After 25 playings the surface noise builds up to that of an ordinary phonograph record, unless a fixing bath is applied. Soft red-shank playing needles, or thorn or fibre, may be used. Steel however is liable to better retain the higher frequencies.

When synchronous playbacks are to be run with picture, "start marks" inscribed on the outer circumference of the record, must be respected. The needle *must* be placed in the outer groove alongside the mark.

Average magnetic pickups run 200 or 500 ohms in impedance. If crystal pickups are used a coupling device may be provided for their impedance which is nearer 100,000 ohms.

CONCLUSION (DISC)

We should not be satisfied that we have the best possible finished product when we merely have a combined roll of synchronized film. Its value may be greatly enhanced if the various strips of film are sorted and assembled (by cutting and splicing) with the view in mind of tying together sequences in such progression as will offer a neatly spliced together story. Scenic or establishing introductions may be followed by sequences divulging the "meat" or objective while leading up to a convincing conclusion.

If superfluous footage be clipped, while that with some meaning or interest be retained in progressive sequences, a gratifying, smooth and interesting flow of continuity will comprise the final product which you may project with pride. Why not tackle this remunerative hobby now so that you may thrill your relatives and friends by projecting a real show 'for and about' them during the rapturous Spring and Summer parties which will soon envelop us all again?

FILM RECORDING

While discussing film recording we will, for monetary reasons, entirely concern ourselves with the indented-film equipment described in the May, 1938, issue of *Radio-Craft*. There are but few of our readers who can afford the more complex variable-area or variable-density sound track equipment as a hobby.

The simpler machine well within the reach of most everyone, both records and projects sound-on-film.

Briefly this indented-film process employs a recording cutting-head with a sapphire stylus not unlike that used in the making of disc records. The head of this unit with its removable weights is so designed that it may serve either as a recorder or, for immediate playback.

When film is passed under the sapphire, while speech or music is applied to the recording head windings, a wavy line corresponding to the modulations is indented 0.002-inch into the film. Basically identical with disc recording. The groove which runs parallel with the edge of the film is too small to be noticeable if impressed upon the back of a picture print. The non-emulsion or glossy side is always used for this type of recording. This in no way harms the picture on the reverse side and offers but negligible wear to the sapphire. Were this unit used for recording only, as many as 28 tracks or records might be laid parallel on one strip of 16mm. film.

SCORING ON FILM

Absurdly simple to accomplish is the feat of scoring one's own voice in synchronism with a 16mm. picture. About 6 ft. of blank film precedes the picture proper—enough to allow the equipment to come up to speed before operation starts. The film is threaded from the upper or feed spool of the projector directly to the sound recording (indenting) head before it reaches the image projector proper.

Set up a microphone sufficiently remote to be shielded from the noise of the equipment and yet where the commentator can comfortably view the screen. Once the equipment is warmed up, if each scene is described as unfolded before the vocalist, the result is a permanently synchronized record impressed upon the back of the picture print. The only other equipment needed is an audio amplifier waiting in most every home radio set. Its input may be fed by the scoring mike while its output is switched to drive the recorder ("indenter"). Cutting heads of any standard impedance are available to meet your particular requirement.

It matters not whether you score a picture taken at the old silent speed of 16 frames-per-second or at the standard 16mm. sound speed of 24 frames-per-second (36 ft. per min.). In either case your recorder being directly in series, nets a synchronized product. You *must* project at the same speed at which you record,—so as not to alter the pitch of the voice.

SYNCHRONIZED PHOTOGRAPHY

The film recording unit can be caused to function "synched" with a movie camera while scenes are being photographed. With such a setup we may bring out genuine Talkies in our own home or even at camp hundreds of miles away provided there are 60-cycle mains available. Mind you, the entire system is readily portable since the recording unit itself weighs but 6 pounds. When you add to that the weight of your camera, mike amplifier and 2 motors, the total is not great.

In this case we cannot thread the device in series as we did in Scoring for naturally the film in the camera cannot be exposed other than as intended through the picture

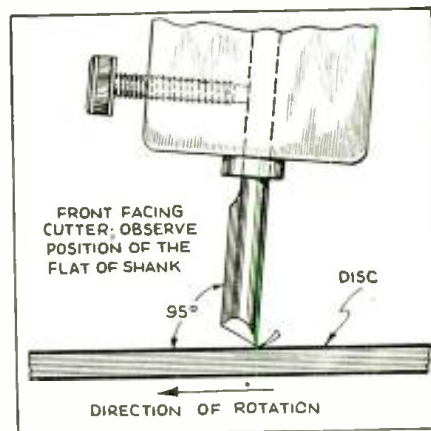

Fig. 4. A good average set-up for cutting-angle and pressure of the cutting stylus.

Table I

A comparison of the characteristics of the different sizes of recording discs at both speeds (78 and 33 1/3 r.p.m.).

Disc Diameter	Average Thickness	Playing Time Per Side	
		78 RPM 96 LPI* 112	33 1/3 RPM 96 LPI* 112
6" —15.2 cm.	.051	1.3 min. 1.6 **
8" —20.3 cm.	.051	2.6 min. 3.0 **
10" —25.4 cm.	.051	3.8 min. 4.5 **
11 7/8" —30.2 cm.	.065	5.0 min. 5.7	7 min. 8
12" —30.5 cm.	.051	5.0 min. 5.7	7 min. 8
13 1/4" —33.7 cm.	.051	5.8 min. 6.8	9 min. 10
16" —40.6 cm.	.051	7.5 min. 8.8	13 min. 15
16" —40.6 cm.	.065	7.5 min. 8.8	13 min. 15

(*Lines-per-inch—LPI—as determined by pitch of the lead screw.

**Records smaller than 12 ins. are not recorded at 33 1/3 r.p.m.).

iris. Some means then must be set up for running a separate film through the recording unit at the same speed and in sync. with the picture film through the camera.

Certainly it would require no genius to mechanically adapt an ordinary 16mm. camera so that it might be driven at its normal speed by a small synchronous 60-cycle motor. It should always be operated at the speed for which the camera was designed as an insurance against damage. The motor should be snugly coupled to the camera through reducing fibre gears so that the complete assembly might still lend itself to normal tripod mounting. Should the motor throw it off balance, compensating weights could be added to its other side so that the photographer could easily "pan" (swing the camera from one side to the other to produce a panoramic picture effect) to follow action.

Electrically locked in sync., through being supplied by the same A.C. mains as the camera, the recording unit is driven by a similar motor. The result would be one film bearing picture and another bearing a

(Continued on page 622)

Making a Shop-Type A.C. TO D.C. POWER SUPPLY

"How many times has the average serviceman, located in or near a large city, been called on to service a direct current radio set, in his service shop supplied only with alternating current!" . . .

GEORGE W. HALDER

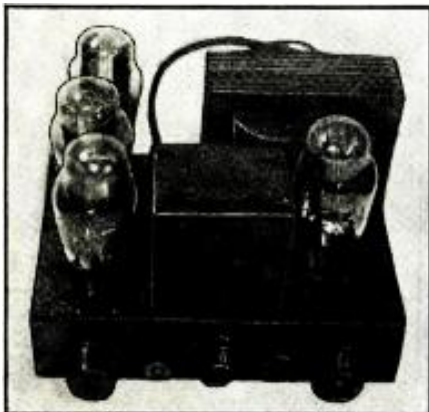

Top view, Halder's A.C. to D.C. Power Supply.

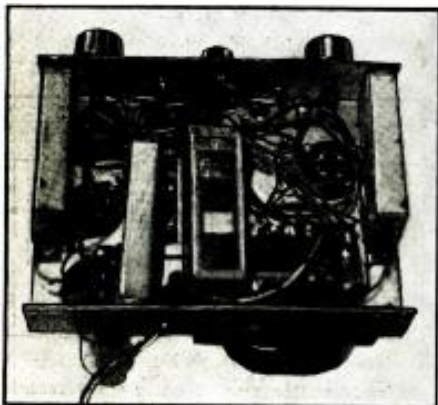

Underside view showing condenser placement.

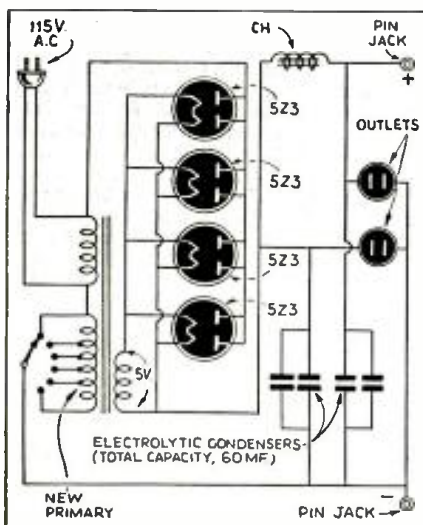

Fig. 1. Four 5Z3's in parallel deliver enough D.C. from 110 V. A.C. to operate a standard 110-V. D.C. radio set. This means \$'s to a service organization in Jamaica Plain, Mass.

THE logical solution is, of course, a D.C. generator supplying the proper voltage, but, direct current generators are expensive, and the average shop does not feel justified in making a comparatively large investment for an item that will be used only occasionally. True, a makeshift repair can sometimes be made on the job, but the results are rarely satisfactory. If the radio set is taken to the shop, resistor measurements and tube checking have to be relied upon and, even if a defective part is replaced, the chassis cannot be aligned, or quality checked, until it is once again installed in the customer's home.

Here is described a direct current converter which anyone can construct in a few hours' time from junk parts to be found in most every service shop.

The necessary parts are:

- One large power transformer (with primary in good condition);
- One choke coil (of not over 40 ohms resistance; taken from power pack of an old D.C. radio set);
- Four 4-prong sockets;
- One 8-point switch;
- Two tip-jacks;
- Two outlet receptacles;
- One chassis (of any suitable size);
- One electrolytic condenser bank (total capacity, 60 mf., 200 V.);
- One hundred fifty ft. No. 24 S.C.C. wire.

The only special item is the power transformer. Any old transformer of 100 to 200 watts capacity (with the primary in good condition) will do. In order to suit our needs, it is necessary to rewind the primary of the transformer and so change it into an autotransformer supplying the necessary 200 volts of alternating current.

HIGH-VOLTAGE WINDING

First, remove the core laminations, then strip off the filament windings, making note of the number of turns used on the 5-volt winding for future reference. The high-voltage winding is most easily removed by using a hack saw to cut the windings in half, being careful not to injure the primary coil.

To rewind the primary about 150 feet of No. 24 S.C.C. wire is needed. Solder this wire to the exposed primary lead, and bring out a tap to be used with the other end of the primary for the A.C. line connection. Wrap a layer of insulating cambric on top of the old primary and wind on 210 turns of wire in

layers, bringing out a tap every 30 turns. This extra primary winding will amount to 4 or 5 layers. Each layer should be well insulated with varnished cambric and the completed primary covered with 4 or 5 layers of cambric.

LOW-VOLTAGE WINDING

Next, the 5-volt winding is replaced. For this 4 No. 18 S.C.C. wires are wound as a unit to insure sufficient amperage for the four 5Z3 tubes. In order to determine the amount of wire necessary, measure the circumference of the primary and multiply this figure by the number of turns used in the original 5-volt winding. This will be approximately 15 feet. Allow at least a foot of extra wire to each length and lay them out parallel on the floor. Bare the ends of the 4 wires and twist them tightly together.

Now wind the 5-volt section, keeping the wire tight and smooth, and counting the turns to duplicate the original 5-volt section. Wrap the completed coil in varnished cambric and replace the core laminations. If it is difficult to replace the last 2 or 3 laminations, they may be discarded and two wedge shaped pieces of wood can be driven in to keep the laminations tight. After the transformer has been re-assembled, the coil should be soaked in insulating varnish and let dry for a day.

The rest of the job is easy. Mount the transformer, choke coil, sockets, etc., in a manner suitable to the chassis you have selected, and wire according to the diagram shown in Fig. 1. In the author's case, a 7 x 10 in. metal chassis provided just enough room to do a neat job.

The plates of the 5Z3 tubes are all connected in parallel to provide half-wave rectification, and the taps from the autotransformer are brought out in proper sequence to the power control switch; the original primary is connected to the A.C. plug.

One D.C. outlet receptacle is connected directly across the output of the rectifier tubes, from the filament winding to the low side of the primary, to supply maximum current for D.C. motors or other appliances where the hum level is not important. The other outlet receptacle is connected after the choke coil to supply pure D.C. to receiver chassis.

When using the power pack, plug the leads from the service voltmeter into
(Continued on page 619)

How The Beam-a-Scope Works!

RADIO-CRAFT believes that the "beam-a-scope" introduces the first commercial application of the principles of the Faraday shield to a loop antenna for broadcast reception. The resulting improvement in the signal/noise ratio, the complete elimination of hand-capacity effect, and the reduction of the directivity characteristic to a narrow segment, mark "beam-a-scope" operation as an outstanding contribution to radio. Finally, the high-efficiency "built-in antenna" thus achieved makes the radio set—whether stationary or portable—completely independent of a ground connection.

OUTSIDE antennas have always been unsightly, subject to damage by lightning, wind, and rain, and frequently in need of repair and replacement. In most cases they have the definite disadvantage of not being designed to fit the requirements of the receiver they serve. The antenna problem has been particularly acute in large cities, because of the prevalence of apartment houses and the great amount of outside interference. Much of the electrical disturbance created in and around the home is conducted through electric light wires and radiates to the receiving antenna and lead-in wire.

The "beam-a-scope", on the other hand, is a shielded loop antenna designed especially for noise reduction. We shall attempt to describe briefly how this is accomplished. To do this let us first consider certain characteristics which all loop antennas have in common.

DIRECTIVITY

In the first place, the e.m.f. (voltage) developed in a loop (see Fig. 1A) is due to the *phase difference* in the field of the incoming signal between its front side AB and its back side CD. This fact gives rise to the well known directivity of the loop, the sensitivity of the loop being greatest when the plane of the loop is parallel to the path of the incoming wave, since in this case there will be a maximum of phase difference between AB and CD. On the other hand, when the plane of the loop is perpendicular to the path of the incoming wave, there is no phase difference between AB and CD, and there is consequently no signal generated in the loop. At the bottom of Fig. 1A is a polar diagram showing the directional characteristics of a loop.

The directional characteristic of a loop is one of the properties used for noise reduction in a beam-a-scope. This is done by so orientating the loop that the principal source of noise is in the direction of zero response of the loop.

ELECTROSTATIC SHIELD

In addition to this, however, the beam-a-scope is surrounded by an elec-

trostatic shield, which eliminates the capacity between the beam-a-scope and ground. By this means, noise which would otherwise be picked up in the ground-return path of the antenna is eliminated!

In Fig. 1B is shown how the elimination of the capacity to ground in a beam-a-scope removes the noise generated in the ground-return path of an ordinary antenna. (We might mention that an unshielded loop, if it were completely balanced to ground by means of a balanced input transformer, would likewise pick-up no noise in the ground-return path. Such a set-up, however, would offer many difficulties in practice.)

The shield around the beam-a-scope furthermore eliminates pick-up from the electrostatic field (commonly called the induction field) around a noise source of the dipole type.

Among dipole types of noise sources are leakage currents from high-tension lines, sparking contacts, etc. As is well known in transmitter work, near a transmitting source there is a strong "electrostatic component" which becomes of negligible importance at a distance of several wavelengths from the antenna. This field is, however, quite important in the case of noise sources in the vicinity of the receiving antenna, but it is eliminated by the beam-a-scope.

CONSTRUCTION

The electrostatic shield around a loop in a beam-a-scope is cylindrical in form, the ends being 2 metal discs, and the side consisting of a woven material (Continued on page 629)



A shield around the loop stops static.

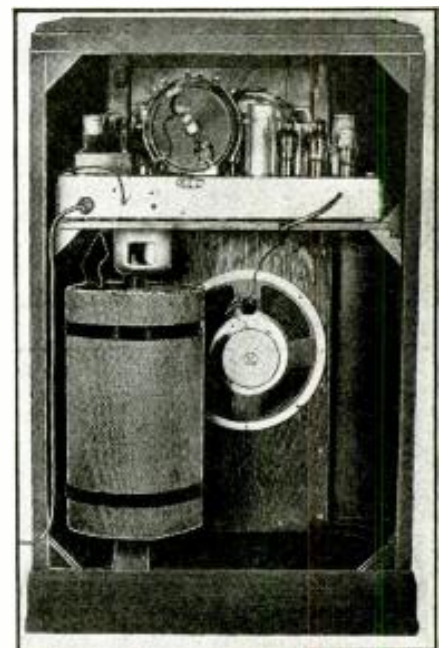

The beam-a-scope is orientated for least static.

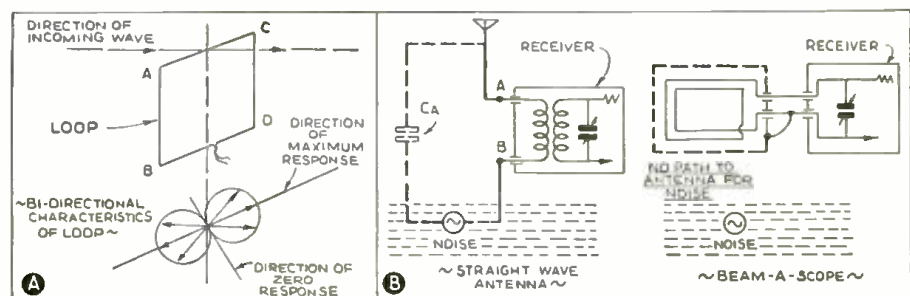
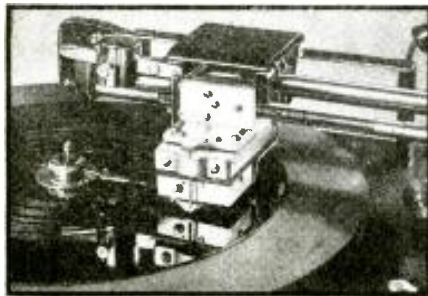

Fig. 1. A—Bi-directional loop; B—Unshielded (left) and shielded (right) antenna systems.

THE LATEST RADIO EQUIPMENT

The address of any mentioned manufacturer will be sent on receipt of a self-addressed, stamped envelope. Mention of item number hastens reply.



Crystal cutter. (1730)

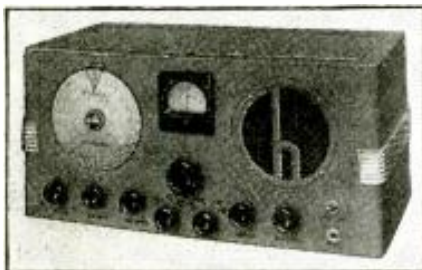

New 5-10 meter receiver. (1731)



Coaxial cable kit. (1732)

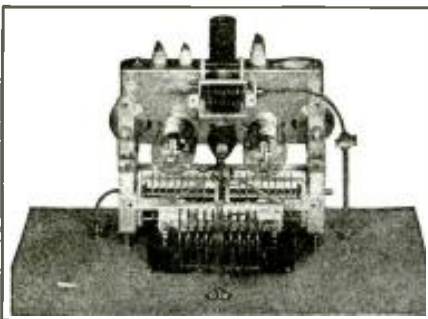

R.F. amplifier kit. (1733)

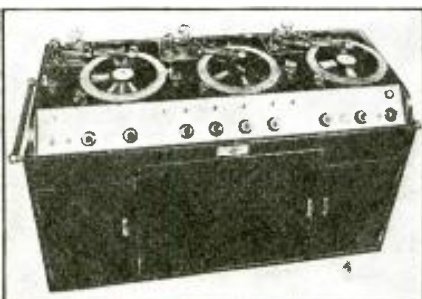

Mobile sound console. (1734)

CRYSTAL CUTTER (1730)

(The Brush Development Co.)

THE ADVENT of modern electrical recording has created a demand for a high-impedance, high-fidelity cutting head. The development of the model RC-1 recording head makes available for the first time a really high-fidelity head at a low price.

A few of the features of this new cutter are as follows: (1) High fidelity, ± 3 db. 30 to 10,000 c.p.s.; (2) No change in quality with depth of cut; (3) Easily adaptable to any carriage; (4) Crystal element waterproofed, hermetically sealed case.

A feature of particular interest of the model RC-1 recording head is that the frequency response may easily be controlled in the driving circuit of the cutter. The high-frequency response may be accentuated by placing capacity across the series resistor. For instance, if a capacity of 0.001-mf. is placed across the 70,000-ohm resistor, the response will be gradually rising above 2,000 and at 10,000 cycles the response will be up 10 or 11 decibels. A lower capacity placed across the resistor will cause less rise at 10,000 cycles. However, this may be altered to suit individual requirements.

The bass response may be changed by means of the resistor shunting the cutter. If the value of this resistor is raised, bass response will be increased, and vice versa. The cutter is, thus, extremely flexible.

NEW 5-10 METER RECEIVER (1731)

(Hallicrafters, Inc.)

THE NEW Skyrider "5-10" receiver is designed specifically and exclusively for tuning on the ultra-high frequency range of 27 to 68 megacycles in which are included the 5- and 10-meter amateur bands, newer international short-wave stations, "apex" high-fidelity broadcast stations and television sound channels.

An 8-tube superheterodyne circuit is utilized including the new 1852 ultra-high frequency tube in the tuned R.F. stage. The new receiver offers numerous features among which are excellent image selectivity, automatic noise limiter, automatic volume control, single knob tuning, wide band spreading, built-in speaker, "S"-meter connections, beat frequency oscillator, stand-by switch, headphone jack, variable band width, tone control, manual R.F. gain control, and an illuminated main dial calibrated in megacycles.

The set will operate either from the A.C. line or from a 6-V. storage battery. When used with the latter an external vibrator supply must be utilized. Thus the receiver is well adapted to either home or portable-mobile operation.

COAXIAL CABLE KIT (1732)

(Transducer Corp.)

A CONVENIENT kit containing all the necessary components for the construction of $\frac{1}{2}$ -in. diameter coaxial cable has been made available for amateurs, experimenters and engineers. These kits include inner conductor, insulators, outer shieldings, clips, screws, nuts, eyelets and instructions for the assembly of the cable. Trade name of the product is Co-X concentric cable.

Insulating beads supplied with these kits are of the Anhygron B ceramic type engineered to last a lifetime. Available in 3 handy kit lengths for 10 ft., 25 ft. and 50 ft. of coaxial cable. These kits make possible the assembly of coaxial cable to any required length at one-third former cost.

R.F. AMPLIFIER KIT (1733)

(Bud Radio, Inc.)

KNOWN as the type BPA-500 this kit is the first of a series of knockdown units intended for amateur construction. It is designed primarily for operation on 5, 10, 20 and 40 meters.



New sound meter. (1735)



New high-mf. low-voltage electrolytics. (1736)



Latest uni-directional mike. (1737)

Outstanding among the many features of this amplifier is the fact that there are no closed loops of any sort in either the tuning condenser or in the layout itself. This has been accomplished through a clever mechanical layout utilizing a semi-skeleton type of construction which entirely eliminates any possibility of parasitics, thus making operation very stable on all frequencies.

The structure of the amplifier is such that it will accommodate any of the various low- and medium-power triodes in push-pull, and while it is conservatively rated at a maximum of 1,750 V. and 500 W. plate input, it is equally efficient at inputs to utilize the BPA-500 with a pair of low-priced triodes at a lower plate voltage. Then at any future date, a power increase is effected by merely substituting more rugged tubes and raising the plate voltage, no mechanical alterations being necessary.

Each kit is supplied complete with wire, drilled and formed sheet-metal rack and panel, hardware, etc., but is less tubes and meters.

MOBILE SOUND CONSOLE (1734) (Wholesale Radio Service Co., Inc.)

THIS Lafayette sound console was constructed especially for the New York City WPA Radio Unit to the exact specification of their engineers. It is intended to provide the sound effects for the extensive musical and dramatic broadcast productions of that organization and as such offers an interesting example of the diversity of application possible with custom-built sound equipment. This sound console is capable of providing any desired sound effects either by direct pickup or from recordings.

Finished in "telephone black" with contrasting metal trim, it is mounted on rubber-tired wheels to facilitate movement from studio to studio; or via truck from station to station. Included in the console are a 4-channel mixer fader system, 3 professional turntables, each with "spotting" mechanism and pickup, microphone input, pre-amplifier, 2 complete 30-W. amplifier channels with individual speakers and facilities for switching any of the 4 inputs through either amplifier channel. Special requirements are high- and low-filter networks, overload indicators, ventilator fans and baffles, and complete manual control of all functions.

The console is 5 ft. long, 3 ft. high and 2 ft. wide. Identical operating characteristics are obtainable from either A.C. or D.C. lines, the latter through the medium of a built-in rotary converter.

NEW SOUND METER (1735) (John Meck Instruments)

CALLED the "Pattern 15 Soundmaster" this portable sound level meter has wide usage in sound and radio work. It has a range from +50 to 130 db. and is directly calibrated on the meter scale in decibels. Accuracy is claimed to be within 1 db. The instrument operates entirely from self-con-

tained batteries. It has a specially calibrated microphone free from directional characteristics. Some of its many uses are analysis of coverage provided by a given sound installation, measurement of the sound level produced by a public-address system or the audience to be covered, comparison of speaker efficiencies, etc.

NEW HIGH-MF. LOW-VOLTAGE ELECTROLYTICS (1736) (Sprague Products Co.)

SEVEN units of these new electrolytics ranging from 500 mf. at 12 V. to 2,000 mf. at 25 V. are available. These condensers are of the dry electrolytic type in round aluminum cans. They are used mainly for filtering action in "A" eliminators and for service with motion picture sound equipment. They are known as the type HLV. Combined solder and screw terminals are provided on the insulated top of the metal can.

LATEST UNI-DIRECTIONAL MIKE (1737) (RCA Manufacturing Co.)

THIS new microphone known as the RCA 77-B is claimed to achieve supersensitiveness on one side and to turn a deaf ear to extraneous noises and echoes on the other. As such it is ideally suited for use in auditoriums and small studios where it will work perfectly when stood in a corner or against the wall. The new instrument is only half the size of the one it replaces (77-A fully described on pg. 654 *Radio-Craft* for May, 1937). The microphone is especially useful in studios having audiences so that audience noise and echoes are cancelled out by the microphone and only that part of the program meant for the radio public goes on the air.

The average operating level is -61 db. with a 10-bar signal across open circuit. The reference level is 0.006-W. It has an average cancellation from the back of -14 to -20 db. It is said to be affected by neither temperature nor pressure changes.

MICA TRANSMITTING CONDENSER (1738) (Cornell-Dubilier Electric Corp.)

THESE new condensers known as the improved type 86 have a very low R.F. resistance and power factor but an extremely high D.C. resistance and negligible power losses. They are designed primarily for use in amateur transmitters. Their current range has been extended to include the 10-meter band (30 megacycles). It is claimed that the new patented design of these units has successfully eliminated corona and reduced internal heating so that the Q or quality characteristic on the high frequencies is exceptionally high. Dielectric loss is said to be remarkably low thereby permitting long periods of heavy-duty operation without change in the electrical constant. These mica condensers are available in 17 capacities at voltages from 2,000 to 12,500 V.

(Continued on page 631)

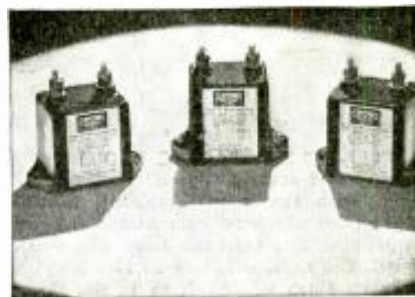

Mica transmitting condenser. (1738)



High-gain 8-W. amplifier. (1739)



New stand-off insulators. (1740)



Binaural amplifier. (1741)

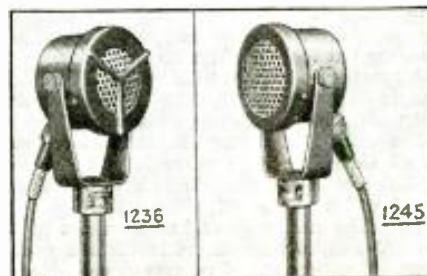

New crystal and dynamic microphones. (1742)

OPERATING NOTES

Trouble with . . .

. . . "JEWEL" SET—PACIFIC RADIO CORP.

I have had several "Jewel" radios in for service with the same complaint, that is, an exceptionally loud hum and a continuous popping and cracking noise like static.

First, the radio sets had no identification marks on them whatever, as to the manufacturer, which would have enabled me to obtain a service schematic in my manuals. So through a little "detective work" of my own I found that the receiver was made by the Pacific Radio Corp., of Chicago, Ill.

The hum was as loud as if one of the filter condensers was open, so I first tried to run down the hum by the regular procedure, trying new rectifier tubes, new filter condensers and substituted a new speaker as the speaker field is used as the filter choke. I even tried larger sizes of condensers but still with no results. I tried the stage-by-stage elimination test and when I pulled the 2nd-detector out of the set, the hum was about half eliminated and the static noise completely quit. I replaced the 2nd-detector tube and took out the 6D6 I.F. tube, and the hum was completely gone; but the static noise was still there.

I checked every part in the I.F. and 2nd-detector input stage, even substituting some of the condensers and resistors that checked OK. But still with no results. I had previously checked the resistance of the secondary of the 2nd I.F. transformer but I did not check the resistance of the primary, as the 6D6 had the correct plate voltage and the current read OK, and my

oscillator signal would go through the set OK. However, I substituted a new 465 kc. I.F. transformer and sure enough there was the hum, for both the static noise and the hum disappeared.

I then checked the primary on my ohmmeter and it read OK. Not being satisfied, I put the transformer in my oven and got it good and warm and then immediately checked the primary and it showed open! I left the test prods attached to the primary and in about 2 minutes' time it read OK again. So in one way I guess you would call this a *high-resistance thermostatic connection*.

I have had 4 of these sets with the same complaint and after I found the bug in the first one, I immediately "jumped" onto the 2nd I.F. transformers in the others and they were in the same condition.

. . . GRUNOW MODEL 11C

I also had quite a little trouble a few days ago in finding the "bug" in a Grunow model 11C. I only had the trouble mentioned below on just this one model, but probably other Servicemen have had it on several as there are only a very few Grunow radio sets in my community.

The trouble was a continuous static noise after the set had been in operation about 5 minutes. I went through the regular procedure of running down the noise, but with no results. So I started at the A.F. end, shorting out the grid of each stage and when I shorted out the grids of the two 6F6 output tubes the noise stopped, but when I shorted out the grid of the 6C5

(driver) the noise was still there. Although the resistors and condensers in this stage checked OK I substituted them with others, but still with no results. Then I installed a new input transformer, although I had previously checked it and it checked OK, but after installation the set worked perfectly (no noise). To be sure that the trouble was due to the transformer and not to a poor connection (rosin, soldered, etc.), I reinstalled the old transformer and in about 5 minutes the receiver started to make the same old noise. I then reinstalled the new input transformer and kept the set turned on (for test) for about 7 hours, and the noise did not return.

FRED E. BERRY,
Berry's Radio Service

. . . ZENITH CHASSIS NOS. 5801, 1004

I have had considerable trouble with the Zenith Shadowmeter as used on Zenith chassis Nos. 5801 and 1004.

The set will play with nearly normal volume but shadowmeter does not function. The trouble is usually located in the 0.05-mf. bypass condenser on the R.F. side of 6C5 shadowmeter tube grid resistor. The condenser shorts and must be replaced to restore normal operation of set and shadowmeter.

. . . ZENITH CHASSIS NOS. 1204, 5909

I have had several instances in the Zenith 1204 and 5909 chassis with the Target Tuning inoperative but the set otherwise func-

(Continued on page 623)

SERVICING QUESTIONS & ANSWERS

PERSISTENT AUTO-RADIO NOISE

(122) Bob Geist, Clarion, Pa.

(Q.) I would like to ask for your advice on eliminating a small amount of motor noise which is still present in a Sears, Roebuck Auto-Radio, Single Unit, 1937, No. 101.458, which I have installed in a 1935 Standard Ford V-8.

The noise-suppression equipment furnished with the radio consisted of a generator condenser, ammeter condenser, curved distributor V-8 condenser, and an engine ground strap. These were installed with the radio receiver.

In addition to these, I put on a shielded lead-in, steering column ground, grounds to the choke and gas feeds, and a muffler ground.

Disconnecting of the dome light took some noise out; incidentally, the built-in aerial is being used, and the shield is pushed well up in the corner post but as the car is a coupe, I thought perhaps the aerial is not big enough.

In a further effort I installed a set of low-resistance, wire-wound spark plug suppressors but it didn't help an awful lot.

A bumper rod aerial with shielded lead-in was tried but only resulted in less power and more noise so that was taken off.

The noise is not wheel noise as it occurs at all times. Perhaps there is some noise condition which is peculiar to a car of that model which you could tell me of.

(A.) The elimination of motor noise in a Ford V-8 radio installation involves a good deal of patience and perseverance. Suggest you try bypassing the electric gas gauge with an 0.5 mf. condenser to ground.

A shielded lead between switch and distributor often helps reduce motor noise. Disconnect red lead at switch and distributor and ground each end. Employ a shielded lead for this connection, grounding the shield well. In extreme cases, a choke coil must be installed in the low-tension lead to the distributor. This coil may be purchased or wound by hand. Thirty turns of No. 14 solid enamel covered copper wire wound on a wood form, 1/2-in. in diameter, and well insulated will suffice.

INTERMITTENT FADING

(123) F. J. Jendryka, Armstrong Creek, Wisc.

(Q.) I have trouble with a Philco 38-7 Model receiver. When connected to a Philco aerial, the reception is something like one would tap the first grid cap with his finger. This action is quite fast and at times the volume comes up and again dies down. The set never dies down completely, but stays at a low level; except at times when it gets louder. At times, turning on a light switch has an effect on the set. Most of the time this set operates at low volume with that fluttering action, although this set works all right with the ground connected to the red connection on aerial terminal. With more noise and other interference, the set works quiet for a 6-tube with only the ground. With only the ground connected, the set sounds all right and not once did I catch it acting the way it does with the aerial. The set circuit does not oscillate with the aerial on or off.

I want to know if it's the aerial, the tubes or some other defect in the set such as coils or condensers.

(A.) The symptoms mentioned in your letter with regard to Philco 38-7 receiver suggest A.V.C. trouble. When an antenna is connected to the receiver, operation is erratic, unstable and choked.

Check the A.V.C. circuit of the receiver. An open-circuited 110 mmf. mica condenser located at the 6J5G socket will cause this trouble. Try a new 6J5G tube in the 2nd-detector A.V.C. stage.

Should the 6J5G tube test OK and the 110 mmf. condenser prove intact, then check the 0.05-mf. tubular condenser, located behind the wave-band switch, for leakage or a short-circuited condition.

SET WORKS ONLY ON PORTION OF DIAL

(124) H. W. Farrar, Dexter, Maine.

(Q.) I have a model 711 Atwater Kent radio set in the shop which, when turned on, 9 times out of 10 will be "dead" from 700 to 550 kc. This is an all-wave set and all short-wave bands are dead from the center of the dial down.

Condenser plates and wave-change switch have been checked as well as all filter and bypass condensers. I have measured all resistors on an ohmmeter, and checked the alignment of the set on 2 different oscillators with very sensitive output meters. Two complete sets of tubes have been tried, but did not seem to remedy the trouble.

Sometimes when the wave-change switch is snapped onto a short-wave position and then back again quickly, the set will come to life on the 550 kc. end of the dial for the broadcast band. When the set is dead on that end of the dial signals up from 700

(Continued on page 640)

All the worthwhile
Radio Trade News
of the past Month—
Digested for busy
radio men.

RADIO Grade Digest

A PLEDGE: — To
print the important
news of the radio
industry; to review
major news events;
to help point a path
to radio profits.

IMPORTANT HAPPENINGS OF THE MONTH IN THE RADIO INDUSTRY

No. 8

APRIL, 1939

NO. 8

No Increase on Tubes In Argentine Tariff

Efforts of the RMA, assisted by the State Department and the Department of Commerce, to prevent a proposed tariff increase on radio tubes in Argentina have been successful. According to recent reports from Buenos Aires, the Argentine Congressional Commission has recommended increase of the duty on incandescent lamps but *not* on radio tubes. That the Argentine Congress and Senate will approve the recommendations is expected.

TELEVISION CONTINUES ADVANCE — EXCEPT IN OPINION OF THE FCC

*Master-Minds in Washington Deny Art Is Ready for Public
Commercialization, Though Admitting Its Progress
— Other News of the Coming Industry*

Hottest news on television is found in the annual FCC report to Congress. The Statement said, in part, that while the technical phases of the television art are progressing in a satisfactory manner, "it is generally agreed that television is not ready for standardization or commercial use by the general public. No applications for commercial authorizations were filed with the commission during the fiscal year.

"Television has developed to the stage where complete transmitting equipment is available on the market, but such equipment is costly and, because of the experimental status of the art, may become obsolete at any time due to new developments. A few of the existing licensees are attempting scheduled program transmissions as part of their research and development work."

(Continued on page 626)

SEE HOW A SUCCESSFUL SALESMAN LOOKS!



The smiling man on the right is C. P. Cushway, general sales manager of Thordarson. He's about to receive the big order which company representative Norman Kathrinus, left, just helped him get from H. W. Bruce, of the Bruce Co., Springfield, Ill. Mr. Bruce is in the middle. Jack Beene, another salesman, was in the deal but out of the picture; he had to click the camera.

RTD Editor Founds Fund for Indigent Broadcasters

A fund which will enable radio broadcasting to take care of its own, whether they be incapacitated performers or studio personnel, was suggested by Robert Eichberg, radio author, and editor of RTD, in a letter sent to the presidents of the National Broadcast-

(Continued on page 626)

BIZ OPPS

There's business for those who will take the trouble to go after it. Here's a hot lead! Is it in your line?

Perhaps YOU can get this business! It's worth while!

J. McNaughton, 3 Pirton Ct., 259 Prince George Ave., Brakpan, South Africa, writes

"Kindly contact me with exporters of radios, parts, P.A. equipment, test equipment, and allied lines. It is most difficult to make contact from this end."

HADLEY TRANSFORMERS GET EXTRA PLANT



In order to facilitate deliveries throughout the East, the Robt. M. Hadley Co., of Los Angeles, has opened an additional factory in Newark, Del. Pres. Hadley has moved to the new quarters.

FACSIMILE HITS THE MARKET!



After much talk, facsimile has reached the market. Some time ago, Crosley Corp. demonstrated its system, using Finch patents, to dealers. This was followed by issuance of 16-page book promoting facsimile to the general public. Cover of book is seen at left; Pages 4 & 5, which give simple explanation of system, appear below. Copy describes line synchronization; states that 13 stations are now transmitting; tells of special paper used for reproduction (\$1 per roll).

SENDING

RECEIVING

STATIONS NOW EQUIPPED TO TRANSMIT PICTURES AND TEXT UNDER THE FINCH SYSTEM

At the present time 13 stations are equipped to transmit pictures under the Finch system and are transmitting experimental programs. All the programs of this nature are transmitted in black and white as they are not subject to the color fading which is inevitable in color facsimile. It is not essential, however, that the receiving set be of the color type, but the transmitting set must be equipped with color system. Under the Crosley Finch system of transmission and reception the pictures are transmitted at 80 cycles, 140 milliamperes and receive set equipped with 150 kilohertz is now limited to hours between 11 P. M. and 6 A. M. Some experiments are being made to transmit facsimile from high frequency broadcasting stations between 55 meters and 17 meters which are available for daylight operation.

Crosley Radio developments include an excellent program of all the power in which pictures are received on ordinary glass white surface, as contrasted with regular receiving sets on wet aluminum and dark colored glass.

CROSLY READO (Radio Printing) TRANSMITTER IS THE NEW ART OF SENDING AND RECEIVING PICTURES

The broadcasting station must be equipped with a device for converting the picture into a sound program. This converting device consists of an electric eye which moves back and forth rapidly across the picture, scanning a line at a time and translating the line by an electric eye into electrical impulses which are transmitted by the broadcasting station in exactly the same manner as in broadcast sound program. Crosley uses the Finch system of facsimile, developed by Mr. W. G. Finch in his laboratory over a period of many years.

THE READO PRINTER CONVERTS RADIO WAVES INTO TEXT AND PICTURES ON WHITE PAPER

Crosley's received under Finch patent, its reproducing equipment designed to receive pictures transmitted by the Finch system. The reproduction of these pictures is quite simple. The material to be broadcast is printed, copied, or photographed on a strip of paper which is fed into the machine a foot at a time and scanned by the photoelectric eye. Just as this strip of paper runs the machine it runs out over the synchronized drum under a full tone engraving and may be received by the Crosley Radio Printer at 1000... more facsimile in size and at the same speed at which it is transmitted.

The RSA Monthly Bugle
(News of the Radio Servicemen's Assn.)

Radio Servicemen of New Jersey have just completed the job of ridding the community of several undesirable trade practices which were endangering legitimate business and undermining public confidence.

Assistance was had from the Postal Authorities, the Racket Squad of the Newark Police Department and a newspaper publisher in the case of a firm advertising "Any Radio Repaired for Only 75 cents, ONE YEAR GUARANTEE." Newspaper ads, handbills placed in mailboxes and billboards were used by this advertiser.

The first step in the campaign to remedy the situation was a strong letter of protest to the newspaper publisher. Result of that move was a satisfactory change in copy.

Complaint by the Chapter was next made to the Postal Authorities, since handbills of postcard size were placed in mailboxes contrary to regulations. Then the RSA Newark organization, through Chairman Carl Rauber, lodged a complaint with the Police Department's Racket Squad, charging fraud, misleading advertising and dishonesty. As a result the matter will be presented to the Essex County grand jury.

Another move to clean up a situation was instituted when a certain store began advertising "Free Radio Service." Again a letter to the newspaper brought favorable results and only 3 ads of a solid 3-week schedule were run.

These 2 examples of employing already existing mechanics of procedure have given the Radio Servicemen of New Jersey a new sense of responsibility and a new fighting spirit. Morale has been raised and we feel that a way has been found to "police" other such situations should they arise.

Over 600 Servicemen were guests of the Metropolitan New York Chapter, at the Capitol Hotel, when John F. Rider explained and demonstrated the Rider Chanalyst.

With television advertised to make its appearance at the opening of the World's Fair, a number of forward-looking Servicemen have joined a special RSA class which is engaged in an intensive study of television apparatus at RCA Institutes.

During December a number of members pooled
(Continued on page 627)

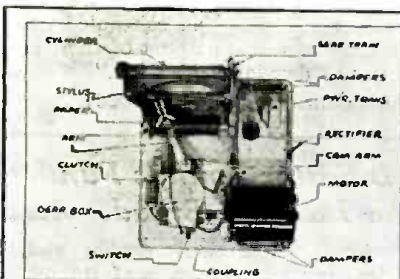

THIS IS THE WAY THE READO PRINTER REPRODUCES PICTURES AND TEXT

THE CROSLY READO (Radio Printing) RECEIVER DESIGNED FOR THE UTMOST SIMPLICITY



CROSLY READO PRINTER MODEL No. 118 \$79.50

Above, left: receiver mechanism—it does not use latest Finch hi-speed triple scanning. Above, right: neat cabinet of reproducer—price is exclusive of radio set.

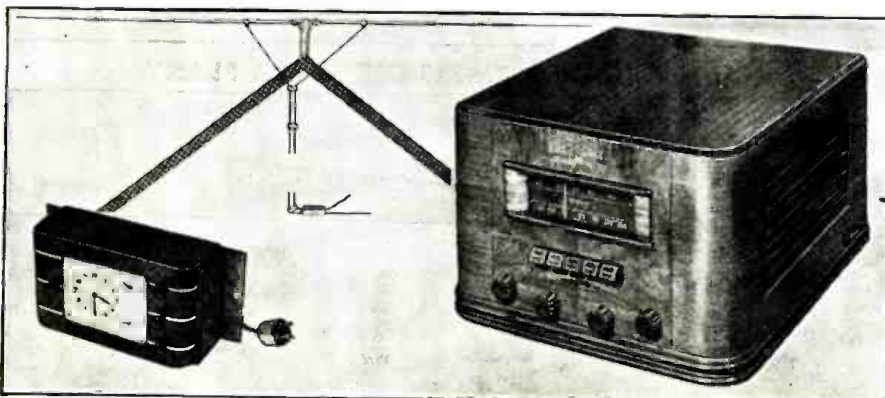

Above are facsimile's adjuncts. At left, a clock to switch it on when transmissions start, off when they stop. Center, a dipole to reduce interference. Right, the \$60 A.C. receiver, not essential but desirable, tunes 540—1,570 kc. & 24—47 mc. Records, not shown, can be used for demonstrations, when pickup is available.

RMA & the Parts Show

The RMA and the Sales Managers' Clubs of New York and Chicago have completed organization for the National Radio Parts Show at Chicago next June. Directors Arthur Moss of New York and H. E. Osmun of Milwaukee represent RMA in the parts show management, while S. N. Shure and A. A. Berard also were reelected to represent the Sales Managers' Club. Mr. Shure again is President and Mr. Moss Secretary-Treasurer of the show management. An innovation of the Parts Trade Show will be the designation of the first 2 days of the show, June 14 and 15, as "Jobber Days," for admission only of jobbers, manufacturers, manufacturers' agents, and engineers to the Exhibition Hall in the Stevens Hotel. The show will close June 17.

RMA members have been advised that the Association's Board of Directors disapproves exhibition of radio parts and accessories, except technical scientific instruments, at proposed exhibits planned in connection with con-
(Continued on page 627)

AN EDITORIAL

By Artie Dee

Don't get panicky! Inventions seldom click overnight—especially when they might disrupt an organized and controlled industry.

Of course the public would like to have "long-life" (50,000 hours) tubes. Certainly it wants "static-free" radio reception. But is that any cause for the trade to get upset? We think not.

The ordinary radio tube of today is in reality a long-life tube, despite the fact that it is rated for a mere 1,000 hours. It is not uncommon for these tubes to remain in satisfactory operation for from 5 to 50 times their rated life. The RTD editor, in fact, has been using some tubes continuously since 1932—and his set is on about an average of 5 hours a day. Those tubes have given more than 12,000 hours and they are still as good as new; they are tested every 6 months.

The "long-life" tubes designed for special service are not subjected to the rigors of inexperienced home use; they are under the control of skilled technicians. If they were abused in home sets—subjected to fluctuating filament voltages, for example—would they still show 50,000 hours of life? There is no published data to that effect. Nor is there available data as to the efficiency of these tubes nor as to their cost, compared with standard receiving tubes.

Don't worry! Long-life tubes won't be cutting into your tube resales this year—or next.

Nor is there cause to worry about "static-free" radio making all present manufacturers' plans just so much waste paper. Desirable as such reception is, RTD does not believe that the billions of dollars invested in present transmitting and receiving equipment

(Continued on page 627)

First List of Exhibitors for 1939 Chi. Parts Show

Preparation for the 1939 National Radio Parts Trade Show being held at the Stevens Hotel in Chicago, June 14-17, went into full swing when announcements and contracts for space were sent to manufacturers of radio parts and accessories.

Response was immediate, and, as the New Year began, more than a 3rd of the total space occupied in last year's Show had already been absorbed.

(Continued on page 628)

Sales Helps and Deals

New Paths to More Business

A new package of Philco display cards includes individual items to push mystery control, the spinet-type console, other consoles, portables, Transitone compact, safety aerial, & the wireless record player. Also in the outfit are special dealer ads, window streamers, price cards & sales cards. It's one of the most complete kits the co. has ever put out. (Other sales helps shown at right.)

Changes & New Addresses

Where to Reach New and Old Companies

PRESTO RECORDING CORP.'s plant & offices have moved to 242 W. 55th St., N. Y. C. Business went up 48% during '38, so the co. is increasing its space 100%—their 4th expansion in 2 yrs.

FORREST C. VALENTINE CO. is back as industrial & jobbers sales reps. of Standard Transformer Corp.

(Continued on page 628)

PLAN AMPLIFIER

SALES PROMOTION

("Lab-Tested" Certificate)

Final plans to promote sales of RMA amplifier manufacturers, providing for RMA "certificates of approval" to be attached to amplifiers made by RMA

(Continued on page 628)

AIDS TO SALES

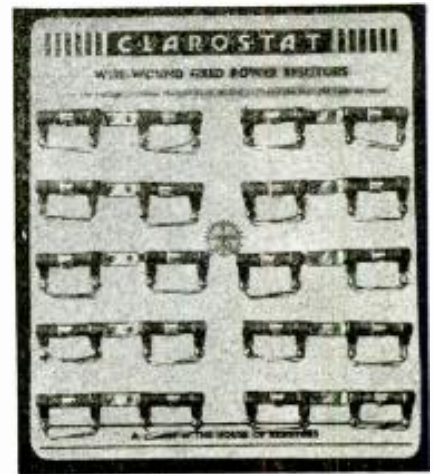

At top: Clarostat's black-&-yellow wall or counter card holding 20 green 10-watt wire-wound resistors, from 25 to 25,000 ohms, is free with assortment. Also pictured is Utah's "Service-Pak," holding 79 basic replacement parts, priced at \$29.95 completely filled.

WINS TRIPLETT CONTEST



H. L. Holmes, Marshfield, Mo., won \$250 worth of Triplett test equip't as 1st prize in the mfr.'s Service Puzzler Contest.

30 YEARS OF SERVICE



Frank C. Englehart has been with Kester Solder Co. for 30 of the co.'s years. And now he is its President. Who says ability doesn't pay?

TAKES ON TERRITORY



William E. McFadden (W8CBL) is new mfr.'s rep. in Ohio, Ind. & Ky. for Standard Transformers, E. F. Johnson, Crowe & Hallicrafters.

EX-ENGINEER; NOW SELLS



Wallace B. Swank, former design & production engineer on Grunow sets, is now mfr.'s rep. on service & ham parts in Mich.



Is the real inside reason of the proposed FCC shift the Commission's consistent "playing down" of television? . . . Consolidated Wire & Associated Corps., of Chicago, are out with a line of carbon fixed resistors . . . The League of American Writers, in N. Y. C., is giving a course in Radio—Geo. Asness, originator & director of the Federal Theater Radio Unit is conducting it.

Burlesque went radio conscious when Carrie Finnell began billing herself as

"The Remote Control Girl" . . . E. L. Moore, publisher of *Radio World*, is listed as its editor . . . Didja see the ribbing of *Philco's* mystery control in the Ella Cinders Sunday comic strip? . . . NBC got 22 more renewals from sponsors.

There are nearly 80 models in the new Wholesale Radio Lafayette line—8 of 'em are battery or farm plant superhets., most of which use no "B" or "C" bats . . . Internat'l Tel. & Tel.'s associated co. in
(Continued on page 628)

Broadcasters and RMA Unite on General Promotion Program

Plans for a national all-industry program for general promotion of radio are in preparation by the National Association of Broadcasters and RMA. The plans will be submitted soon to the Boards of Directors of both organizations. A substantial initial fund to develop the national program has been voted by NAB and RMA.

Committees of the NAB and RMA, headed by their respective presidents, Neville Miller of Washington and A. S. Wells of Chicago, met to discuss the new project, designed in the interests of broadcasters, manufacturers, and also distributors, dealers and servicemen. The RMA Board of Directors on December 1 authorized an appropriation for preparation of the promotion program and an equal appropriation was made by the NAB Board of Directors.

The public service rendered by radio will be emphasized in the promotion
(Continued on page 628)

\$'s & N^o. 's Dept.

"There's Magic in Numbers"—Sir Charles Perth.

WOR LED in popularity, according to a Hooper-Holmes inspection of dials in auto radios. 5850 cars were inspected; 40% had radios. Only the 4 N.Y. 50 kw. stations were considered. Of the sets, 23% were tuned to WOR; 17% to the 2nd station; 13% to the 3rd; 10% to the 4th.

SPONSORS SPENT \$68,808,076 on air time in '38. Extra \$\$ for talent & material brought the bill to more than \$100,000,000.

BIGGEST SPENDERS for radio programs, according to *Motion Picture Herald*, were: Agencies, Blackett, Sample & Hummert, \$8,955,633; NBC Sponsors, Proctor & Gamble, \$4,860,155; CBS Sponsors, Lever Bros., \$2,790,141; Products, Food & Food Beverages, \$21,156,602.

(Continued on page 628)

Personal

The Industry will mourn the passing of LeRoy H. Link, secretary-treasurer of the G-E Supply Corp. since its formation in 1929, and member of the Finance Committee of the Natl. Electric Wholesalers' Assn. since the same year. Mr. Link was 56 years old.

These Men Make Industry News

Robert Shannon, former vice-pres. & gen. mgr. of RCA Mfg. Co., has been elected Executive Vice President. His first job in an electric light co. paid 17½c an hour, when he landed from Ireland.

Gerald McL. Cole is direct sales rep. of Standard Transformer Corp.'s jobber sales division for the entire state of Ill.

Horace G. Martin, inventor & mfr. of the Martin Vibroplex sending key, has retired. His sons, Robert W., & John W., are continuing making keys, sounders,
(Continued on page 628)

OFF THE PRESS

Latest Publications to Keep You Informed

HOW TO DESIGN YOUR OWN TUBE CHECKER. John Meck Instruments Co., Chicago. Suggestions & discussion.

CATALOG. Allen B. Du Mont Labs., Passaic, N. J. Printed in 2 colors; describes home television sets & deals with entertainment possibilities.

RADIOGRAM. Terminal Radio Corp., N. Y. C.
(Continued on page 629)

SARNOFF SUMS UP

David Sarnoff, President of RCA, summed up 1938, saying, "The year just ended inherited the business slump of 1937, which impeded progress for the first 6 months. By the mid-year, however, general business conditions began to pick up and the second 6 months witnessed substantial improvement in all branches of the radio industry. The
(Continued on page 626)

OLD MFR.'S NEW LINE



Bendix, one of biggest names in aviation & auto fields, has entered radio instrument biz with new co., Bendix Radio Corp. "Radioscope" shown is one of line of quality instruments.

ONE OF G-E'S '39 SETS



Five table models (4 A.C.-D.C.), 3 consoles, & wireless record player comprise General Electric's 1939 receiver line. Two of the consoles have phono switch. Phone unit incorporates mike plug.

LAFAYETTE WIRELESS UNIT



New wireless record player by Wholesale Radio Service Co. rounds out the famed Lafayette line. New unit sends modulated 1,200 kc. carrier; provides mike plug, too.

ZENITH "WAVEMAGNET" MODEL 6D315 A.C.-D.C. LOOP-PORTABLE (Chassis No. 5657)
 5-Tube (and ballast) Superheterodyne; A.C.-D.C. Portable; Built-in "Wavemagnet" (Shielded-Loop) Antenna; A.V.C.; Broadcast Band, Range 540 to 1,550 kc.; Beam-tube Output 1.6 Watts; 5-in. P.M. Dynamic Speaker.

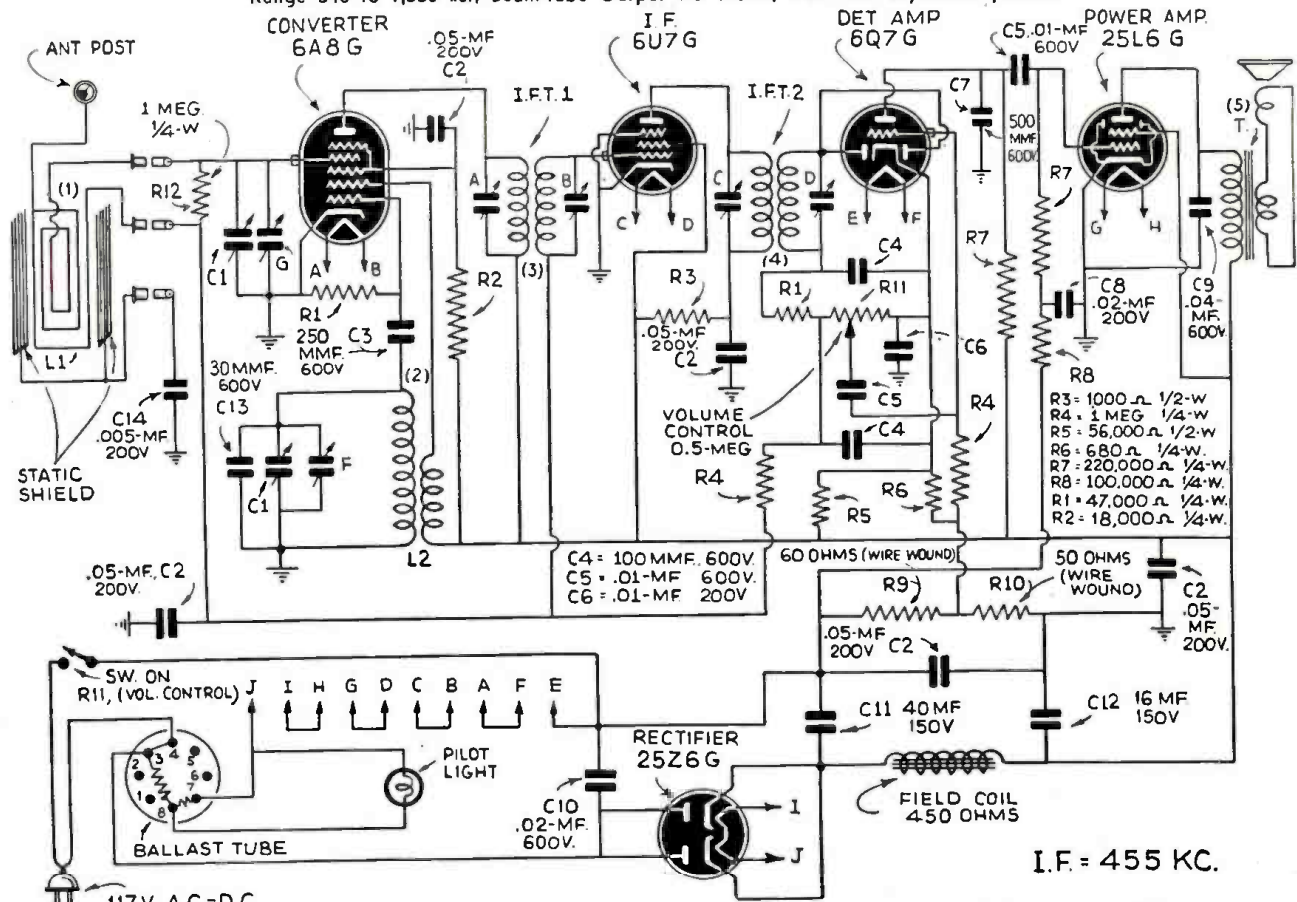

117V. A.C.-D.C. Diagram of the A.C.-D.C. portable loop receiver. Ideal for hotels, hospitals, offices and apartments, in fact any type of home.

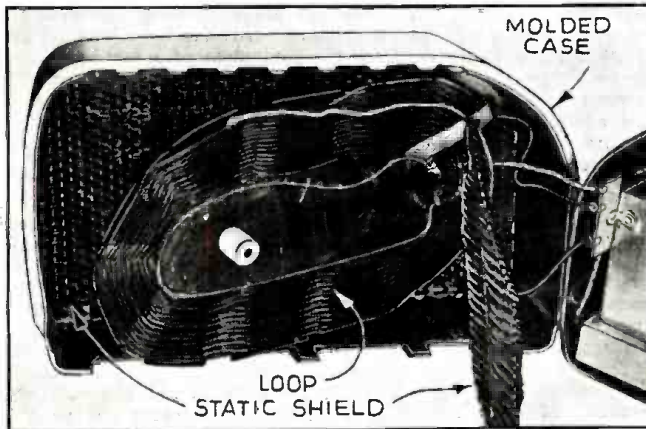
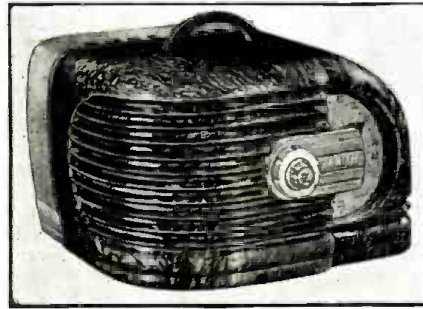
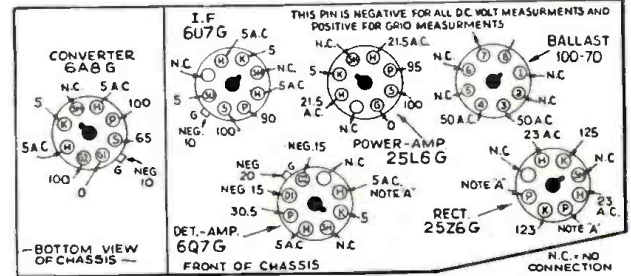

Photo of the spiderweb-wound loop antenna and its electrostatic, Faraday-type shield. Latter consists of 2 sets of vertical copper wires, soldered together at one end and open at the other, held in place by interlaced, insulating cords.



The Zenith Model 6D315 A.C.-D.C. Portable.



Underside view of tube sockets showing operating voltages.

ALIGNMENT PROCEDURE

Voltages measured from No. 7 pin on ballast tube to point indicated using a 1,000 ohms/volt meter. Vol. control at minimum. Antenna disconnected. All filament voltages measured across each respective tube, using a 0-30-V. A.C. voltmeter.

(A) Plate voltage of 25Z6G shows 110 V. A.C. measured from plate of 25Z6G to No. 7 pin of 6Q7 socket.

To align I.F. connect test oscillator to 1st-detector grid through dummy antenna of 0.5-mf. Set test oscillator to 455 kc., dial to 600 and adjust trimmers A, B, C and D. To adjust calibration of dial connect test oscillator to antenna lead of receiver through dummy antenna of 200 mmf. Set test oscillator to 1,500 kc., dial to 1,500 kc. and adjust trimmer F. To align antenna stage connect test oscillator to antenna lead of receiver through dummy antenna of 200 mmf. Set test oscillator to 1,500 kc., dial to 1,500 kc. and adjust trimmer G.

The Faraday shields, placed one on either side of the spiderweb loop, must always be in position in order to maintain proper ganging of the tuning condensers. They help eliminate static from such interference radiators of the dipole type as elevator motors, appliances, neon signs, etc. Need for a ground or antenna is completely eliminated.

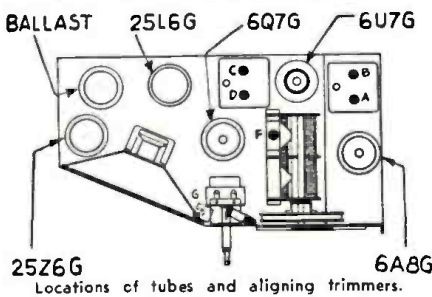

I'LL SHOW YOU HOW TO MAKE REAL MONEY IN RADIO AND TELEVISION



New Practical HOME TRAINING fits you quickly

YOU GET
Professional TEST EQUIPMENT plus EXPERIMENTAL OUTFITS!



146 RADIO PARTS
•
RADIO TOOLS
•
All-Purpose, All-Wave ANALYZER



I'll Prove That You Can Have

A GOOD JOB IN RADIO . . .

OR A BUSINESS OF YOUR OWN

I offer you a new and altogether different type of practical training for a money-making career in Radio and Television. No matter if you desire to BE YOUR OWN BOSS in your own business, or hold down a good job in Radio, my Personalized Training will give you the useful knowledge to win success.

EASY to LEARN -- EARN from the START

YOU DO PRACTICAL EXPERIMENTS with real Radio Equipment . . . with your own hands. Thus the principles of Radio become crystal-clear to you. The valuable spare-time BUSINESS BUILDERS I supply will show you how to put this knowledge to work in handling profitable Radio service jobs while learning.

NO PREVIOUS EXPERIENCE NEEDED

It makes no difference what your education has been. My Training starts at the beginning of Radio covers in a simple understandable style all essential subjects including Television, Electronics, Facsimile Radio, Radio Set Repair and Installation.

READ WHAT THIS STUDENT SAYS

"Earned \$250 Since Starting Course"

"I have only completed one third of the Sprayberry Course and I find it very interesting, which makes it easy to learn. By devoting several hours spare time daily to studying and servicing I have made about \$250 gross since starting the Course."
Earl W. Hostetter, R. No. 4, Lebanon, Pennsylvania.

SERVICEMEN

I offer Advanced Training for those already in Radio. Get complete details in my FREE 52-page Book.

REMEMBER—THE SPRAYBERRY COURSE IS SOLD UNDER A MONEY-BACK AGREEMENT



RUSH THIS COUPON FREE for BIG FREE BOOK

DON'T DELAY! ACT NOW!

SPRAYBERRY ACADEMY OF RADIO
F. L. Sprayberry, Pres.
220-D University Place, N.W., Washington, D. C.
Please send me FREE copy of "HOW TO MAKE MONEY IN RADIO."

Name Age

Address

City State

Tear off this coupon, mail in envelope or paste on penny postcard. Servicemen—Check here

A MODERN AMPLIFIER FOR RECORDING AND PLAYBACK

(Continued from page 591)

listening to the players directly. (A condition brought about by *intermodulations, between instruments, which produce excessive 3rd, 5th, and 7th harmonics during the production of a strong sustained fundamental tone.)

3. Placing of microphones, arrangement of players, and studio acoustics have a profound effect upon the quality of the finished record.
4. The judging of the quality of a given record by a group of listeners (expert or otherwise) usually produces a wide variety of opinions and is dependent to a great extent upon the amount of aural degeneracy to which a listener has been subjected. Prolonged listening to "cigar box radios" for instance, produces an exaggerated appreciation of low frequencies, while continued listening to programs with tone controls in "low" position (high-frequency cut-off) produces abnormal aversion to high frequencies. It is therefore apparent that the recorded program should only sound like the original when and if the original sounds are pleasant.

signal from the 2nd stage into 4 isolated channels (low-pass, band-pass, high-pass, and all-pass). The low-pass filter passes all frequencies between 0 and 300 cycles, the band-pass filter passes only those frequencies that lie between 300 and 3,000 cycles, whereas the high-pass filter passes all those frequencies between 3,000 and 20,000 cycles. The all-pass equalizer passes all frequencies and includes an equalizer to compensate for interelectrode tube and wiring capacities.

The values for the chokes and condensers employed in the various filters are not given, inasmuch as considerable variation is encountered both in inductance and stray capacity, which are largely dependent upon the type of coil construction, condenser, shield, and sealing compound employed. It is therefore recommended that those technicians desiring to build their own amplifiers, purchase these filters in the factory finished form so as to insure proper operation of their completed amplifier.

DEGENERATIVE 6V6 DRIVER

The use of a degenerative driver insures an unusually low impedance coupling into the 6L6 output stage and minimizes grid-circuit distortion.

For some unaccountable reason, there is an old school of technicians who persistently use 2A3 tubes. The usual contention is that there is nothing like a low-mu low-impedance triode for quality. The fact of the matter is, however, that quality, when defined in relation to harmonic content, is alike in all tubes rated at a given total harmonic content.

The problem, however, of properly matching the output stage into a magnetic cutter (which usually reflects a varying impedance into the plate of the output tubes) deserves serious consideration when high-impedance output tubes are employed. The generous use of inverse feedback through a tertiary (3rd) feedback winding provides for the equivalent of a low-impedance output circuit, and insures a constantly proper match of the cutter to the output tubes.

POWER SUPPLY CONSIDERATIONS

Extraordinary care has been exercised in the design of the power supply so as to minimize distortion usually caused by faulty screen-grid or plate regulation. It will be noted that the high-voltage A.C. is tapped and fed to a separate rectifier to provide 300 volts for the screen-grids of the 6L6G tubes. This procedure eliminates the usual series resistor which prevents ideal regulation in this circuit. All condensers in both filter supplies are 450 volt working. Series 20-mf. condensers are used in the plate supply circuit so as to insure an adequate safety factor, and trouble-free performance.

ADDITIONAL USES

The high-fidelity performance of this amplifier, plus its unusual tone compensating system makes it admirably adapted for all P.A. applications, as well as for the high-quality amplification of phonograph recordings. It is not necessarily limited solely to the making of records. In fact, amplifiers of this type have been built for an appreciable number of music lovers who want nothing but the finest.

This article has been prepared from data supplied by courtesy of Amplifier Company of America.

AUDIO SPECTRUM CONTROL ANALYSIS

Inasmuch as the circuit is divided into 3 audio bands (0-300, 300-3,000, 3,000-20,000 cycles) it becomes a comparatively simple matter to insert either one of the 3 bands and note the intensity of the sound level on the volume indicating (or "V.I.") meter. Under a properly-balanced condition, the intensity of the low, middle, and high frequencies will be nearly equal. It is a condition of this type which insures a production of a well-balanced recording.

Disastrous overloading "lows" can easily be detected when the low-pass filter is the only interconnecting link between the 3rd and 4th stage. Proper placement of the instruments can readily remedy any such known defect. By introducing the band-pass filter into the circuit, and eliminating the low-pass unit, an exact analysis may be made of the intensity of this band of frequencies. The high-pass filter may be similarly employed.

A series of interesting and instructive experiments may be conducted by playing commercial records through the amplifier with each of the filters placed into the circuit successively and noting the relative V.I. readings. By adjusting the filter controls, it becomes possible to balance all frequencies and obtain a surprisingly pleasant rendition from known records of deficient quality.

UNUSUAL FEATURES

The design of the amplifier evolves itself around the use of the latest-type single-ended tubes in high-fidelity circuit so as to prevent abnormal high- or low-frequency attenuation. A decided improvement over the audio spectrum control amplifier described, for the first time in any radio magazine in the December, 1937, issue of Radio-Craft, is the electronic isolation of the various filters.

It will be noted that two 6SC7's are employed to branch the electronically-mixed

* A comprehensive article on this topic is scheduled to appear in the forthcoming issue of Radio-Craft.—Editor

Please Say That You Saw It in RADIO-CRAFT

RCA-VICTOR "PICK-ME-UP" MODEL 94BP4 BATTERY LOOP-PORTABLE (Chassis No. R-C 410)

4-Tube Superhet. Battery Portable; Broadcast Band (range 550 to 1,560 kc.); Battery Drain, "A" 0.24-A, "B" 9 ma.; 5-in. P.M. Dynamic Speaker; A.V.C.; Built-in Unshielded-Loop Antenna. Class A Output (undistorted) 0.1-W.; max., 0.21-W.

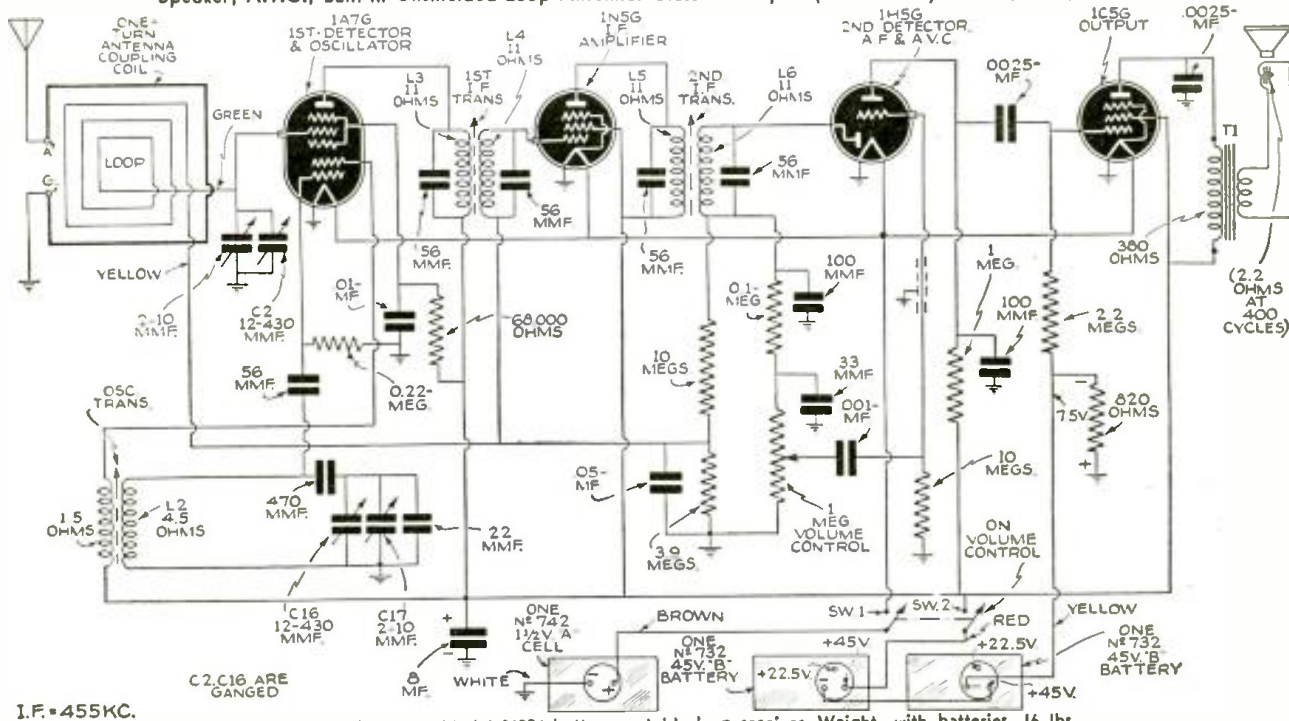

I.F. = 455 KC.

Diagram of RCA-Victor Model 94BP4 battery portable loop receiver. Weight, with batteries, 16 lbs.

ALIGNMENT PROCEDURE

Output Meter Alignment.—If this method is used, connect the meter across the voice coil, and turn the receiver volume control to maximum.

Test-oscillator.—For all alignment operations, keep the output as low as possible to avoid A.V.C. action.

Pre-setting Dial.—With gang condenser in full mesh, the pointer should be horizontal.

Precautionary Lead Dress.—

1. Dress speaker leads down to chassis.
2. The green lead from the loop to the antenna section of the gang should be dressed between the output and detector tube shields and pulled toward the far corner of the loop by means of the rubber band.
3. The spiral shield on the 1st A.F. grid lead should be brought as close as possible to the grid cap.
4. Leads to the high side and tap of the volume control should be dressed down to the chassis and away from the output tube plate lead.

Antenna.—An antenna and ground may be connected to "A" and "G" at bottom of cabinet. If total length of antenna and lead-in is more than 150 feet, connect a 300-mmf. condenser in series with lead-in.

Steps	Connect the high side of test-oscillator to—	Tune test-osc. to—	Turn radio dial to—	Adjust the following for max. peak output—
1	1N5-G grid cap. in series with .001-mf.	455 kc.	Quiet point between 550-750 kc.	L5 and L6 (2nd I.F. transformer)
2	1A7-G grid cap. in series with .001-mf.	455 kc.		L3 and L4 (1st I.F. transformer)
3	Assemble chassis and batteries in correct position in cabinet, and fasten rear cover (loop) in place while making the following adjustments, which are accessible through holes in the bottom of the cabinet.			
4	Antenna terminal, in series with 200 mmf. Connect low side of test-osc. to "G" term.	1,500 kc.	1,500 kc.*	C17 (osc.) C1 (ant.)
5		600 kc.	600 kc.*	L2 (osc.) Rock in
6		Repeat steps 4 and 5.		

*Use bottom of "1" in "150" for 1,500 kc. calibration point, and use center of "0" in "60" for 600 kc. calibration point.

Cables plug into the batteries, making battery replacement an easy matter. Carefully note the position of each battery before it is removed from the set; they must be replaced in exactly the same positions. As the schematic diagram shows, no "C" battery needed. The power tube obtains its bias from an 820-ohm resistor in the negative lead from the first "B" battery to chassis.

RCA-Victor Model 94BP4 Battery Portable.

View of the pancake-wound loop built into this receiver. This set may be used as an interference locator due to the directivity characteristics of the loop as well as to the fact that the loop is not electrostatically shielded. An external antenna and ground may be used with this set too.

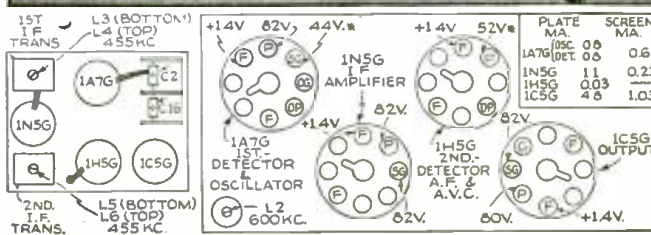
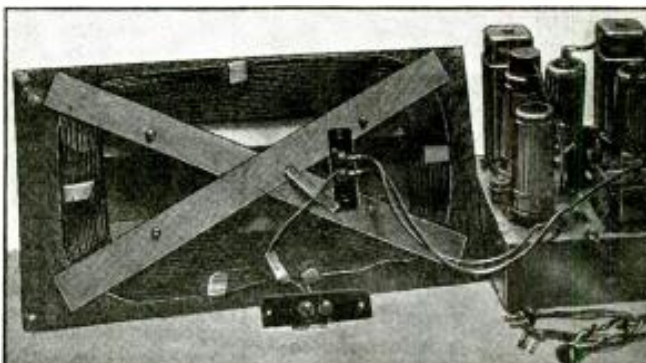
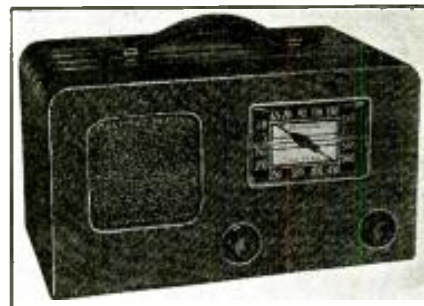

OPERATING VOLTAGES

Note: Values with star (*) are operating voltages. Values not starred are actual measured voltages. Measurements are made to chassis unless otherwise indicated, with set tuned to quiet point. Values should hold within approximately ± 20% with rated battery voltage.

Meet Your Left Hand!

THE HAND THAT FEEDS YOU

Ghirardi's MODERN Radio SERVICING

This is the big book that gives you the solid background of theory you need to do intelligent radio service work today. It's the "Service-man's Book of Knowledge" . . . a huge compact storehouse of essential facts . . . ALL the facts. Here's where you'll learn the latest factory-servicing methods—all about testing and repairing as practiced today by leading radio service organizations.

Fundamentals Made Plain

Ghirardi gives you a quick, vivid, indelible picture of the whole servicing field. Things you never quite understood before will become as clear as 12 and 24. This one book will add thousands of hours of invaluable experience to your own—show you how to do service jobs quicker, better, more profitably! Without it, you're actually short-handed. With it, you're fully and instantly prepared for anything! Get it today, with **MONEY-BACK GUARANTEE!**

- **Test Equipment**
A 420-page section, giving you the whole theory and construction of every type of test and servicing equipment. Diagrams, construction data, etc., etc.
 - **Trouble-Shooting**
254 pages of latest short-cuts in tracking down all kinds of receiver troubles.
 - **Repairing**
184 pages of time-saving repair methods; superhet alignment; interference elimination; etc., etc.
- 1300 Pages**
706 Illustrations

\$4

MAIL NOW!

RADIO & TECHNICAL PUBLISHING CO.
45 Astor Place, New York, Dept. RC-49
 Here is \$3.00 for my copy of MODERN RADIO SERVICING.
 Here is \$1.30 for the special limited-time price of the TRUBLE-SHOOTER'S HANDBOOK.
 Name _____
 Address _____
 City _____
 State _____
 Please send free literature describing contents of MODERN RADIO SERVICING.

Servicing is a job for 2 HANDS USE THEM! Get Both Books TODAY

New Style and Performance to Modernize Your Equipment at Amazing Low Cost!



MODEL 55C

Side open cupler, 15 ft. cable, Level—50dB, 50-7000 cycles, Free wiring diagrams.

New TURNER Torpedo Crystal Microphone

It's easy and inexpensive to give your equipment up-to-date good looks and top-quality performance with the new Turner Torpedo. Impressive full-plated finish. Streamline design and absolute absence of peaks reduce feedback. Guaranteed to out-perform many mikes selling for 50% more! Works directly into grid of almost any amplifier. Order today!

Write for Bulletin 41-A. Learn all about the latest developments in microphones. Details and applications of all models given in Free Bulletin 41-A. Know your stuff about mikes; write for your copy today!

\$15.95 LIST

THE TURNER CO.
CEDAR RAPIDS, IOWA

Licensed Under Patents of the Brush Development Co.

MANUFACTURED SPEECH!

(Continued from page 586)

ear for speech sounds, but also a very perfect synchronization of feet, hands and arms.

RELAXATION OSCILLATOR

The source for this sound is the so-called "relaxation oscillator" which gives a sawtoothed wave in contrast to the smoothly rounded wave of a pure musical note. This sawtoothed wave has a fundamental note which gives the whole sound a definite pitch. Broad changes in this pitch mark the difference between male and female voices; gliding change of pitch over a smaller range constitutes inflection. The Voder may be posed as a man or a woman by turning a knob (!); it may state a fact, ask a question or emphasize a word according to the motion of its pedal.

When one talks one shapes his mouth cavity so that some particular parts of the complex sound come through clearly while other parts are suppressed and unheard. This makes the difference between the vowel sounds. For the same purpose the Voder is provided with 10 keys. Each of these operates a variable attenuator to control the current in a definite frequency range. Source of current for each attenuator is an electrical filter which picks from the sawtooth wave one particular group of its overtones. Normally each attenuator is on open-circuit, so that no sound comes through. The vowel sounds require the selection of only 1, 2, 3 or 4 ranges of overtones; the other ranges contribute nothing to the sound. In human speech, some sound is found in every range, but the Voder seems to speak most understandably when the unimportant overtones are suppressed.

Considering all the keys, there are 23 different sounds available to the Voder operator. By combination of keys she can mix these sounds and by the fingering she can control the shading. All speech sounds can be produced, but the number any operator can make use of depends on her finger dexterity; even granted the ability, only long practice will bring skill. The young ladies who will operate the Voder at San Francisco and New York were selected from more than 300 telephone operators; and through long practice they have acquired a sufficient vocabulary to converse on ordinary subjects.

Sounds in the Voder's repertoire are not confined to those of the human voice. Bleating of sheep, lowing of cattle, grunting of pigs, and even the rat-a-tat of the woodpecker can be produced with perfect realism.

The Voder is an outgrowth of fundamental researches in telephony carried on in Bell Telephone Laboratories. Homer W. Dudley in the course of one of these researches developed a speech synthesizer which could be controlled electrically by a speech analyzer. Successful outcome of his work was demonstrated in September, 1936, at the Harvard Tercentenary in Cambridge. When the Bell System exhibits were projected for the Expositions at San Francisco and New York, the synthesizer part of the apparatus seemed to offer possibilities for development into a novel demonstration which would have educational value since through its use the formation of speech sounds could be shown. Mr. Dudley and R. R. Riesz thereupon constructed a model which has been put into form for exhibition by W. A. MacNair of the Laboratories' technical staff. Difficult tasks of working out its linguistic possibilities and a technique for its operation were un-

Now Meet Your Right Hand!

THE HAND THAT SPEEDS YOU

NEW-RADIO Trouble-Shooter's HANDBOOK

Case Histories
Trouble symptoms and remedies for 3,313 sets, compiled from actual service records.

I. F. Peaks
Over 15,000 Institutes for alignment of all superhets, old and new, including 1939 models and "orphanans."

Auto-Radio
Gear Ratio and Dial Directions of Tuning Controls of all sets; Installation and Car Ignition Systems Data for all cars; Special Interference Elimination instructions for over 80 car models; Electrical Wiring Diagrams; and over 30 other invaluable charts and tables.

Don't be a one-handed serviceman. Supplement **THEORY** with ready-to-use **short-cuts**—supplied you by Ghirardi in quick-find tabulated form for quick-as-a-flash reference. You'll get them all in this brand new **HANDBOOK** of practical servicing—invaluable, indispensable bench-data you'll use as often as your tube-tester.

Practical Job Data

Stop guessing! Stop fiddling! Stop time-wasting! Get the habit of going to Ghirardi, the No. 1 Problem-Solver in the radio world. You can't find to work in your shop for only \$1, the price of this two-fisted, quick-on-the-trigger, handy handbook. But you need not be a cent out of pocket! Either the book buys you a profit and you keep it; or you return it for your money back. You can't lose, so give yourself a break and send for the book—**AT ONCE!**

508 PAGES
134 Illus.
Standard Manual-Size (8 1/2x11)

\$3

MAIL NOW!

RADIO & TECHNICAL PUBLISHING CO.
45 Astor Place, New York, Dept. RC-49
 Here is \$3.00 for my copy of MODERN RADIO SERVICING.
 Here is \$1.30 for the special limited-time price of the TRUBLE-SHOOTER'S HANDBOOK.
 Name _____
 Address _____
 City _____
 State _____
 Please send free literature describing contents of MODERN RADIO SERVICING.

Servicing is a job for 2 HANDS USE THEM! Get Both Books TODAY

DATAPRINTS

- TESLA-LOUDIN HI-FREQ. COILS**
- 20c Ea. in order for 10 (Data and Drawings only.)
 - 36" Sp'k Tesla-Oudin Coil 40c (1 K.W. Exc. Trf. Data, included FREE!)
 - 8" Sp'k Tesla-Oudin Coil 40c (1/4 K.W. Exc. Trf. Data, included FREE!)
 - 3" Sp'k Oudin; 110 Vt. "Kick Coil" type.....40c
 - 3" Sp'k Tesla Works on Ford Sp'k Coil.....40c
 - 1" Sp'k Violetta Hi-Freq. Coil.....40c
- FREE with order \$1.00 or more—20 Tricks with Hi-Freq. Coils (40c separate)

20 ELECTRIC PARTY AND LODGETRICKS! Loads of Fun!

How to Shock 'em!.....40c
Order with other prints.

See special price below and save.

Special Prices:
4 prints \$1.00; 10 for \$2.00;
40c each, single orders.

The DATAPRINT Co.
Lock Box 322B, Ramsey, N. J.

Please Say That You Saw It in RADIO-CRAFT

dertaken by S. S. A. Watkins, who developed a course of training and instructed a corps of operators.

To its intimates, the Voder is known as "Pedro" as a reminder of an interesting bit of history. In 1876 the telephone itself had just been invented, and it was on display in Philadelphia's "Centennial Exposition." Dom Pedro, Emperor of Brazil, was asked to listen while someone talked from a few hundred feet away. "My God! it talks," he exclaimed. Were Dom Pedro alive and in Philadelphia today, he would not marvel at hearing voices by wire and radio from his capital, but if he heard words that had never come from a human voice his exclamation of 1876 might well be repeated.

NEW CIRCUITS IN MODERN RADIO RECEIVERS

(Continued from page 600)

tively shorted across the plate load circuit. The actual impedance of this circuit at resonance is zero, and there is a net resistance which is the sum of the D.C. coil resistance and R.F. resistance of the coil. This may amount to about 10 or 15 ohms in the average case. The frequency component for which this is true will be practically all lost to the signal circuit.

By placing the filter here, it is much less detuned or changed in characteristics than across the antenna circuit, especially where a band changing arrangement changes the electrical characteristics of the antenna circuit.

(5) NEW-TYPE TONE CONTROL DOES NOT AFFECT VOLUME SETTING

Westinghouse Models WR-212, WR-212X, WR-312 and WR-312X. These circuits make use of a new type of tone control, which carries the same signal current for every setting and hence, requires no manual volume compensation with its adjustments.

The usual tone control bypasses various amounts of energy across the signal circuit to ground and hence for each setting the volume control must be reset to restore the original average volume. However, with this control (see Fig. 2C), the average signal level is the same for every setting.

With the slider at the top, the circuit functions as a normal amplifier with a very slight signal current flowing through the tone control. When the slider is turned to the bottom of the 1/2-meg. potentiometer there is no change in the signal current through the tone control. Although the signal must now be transferred through the 1/2-meg. potentiometer to the grid, there is no appreciable drop for very low frequencies. On the other hand, for high frequencies above 1,500 to 2,000 cycles there is an increasing signal drop across the potentiometer because the higher the frequency the less complete can be the charge and discharge of the tone control condenser. Hence at 10,000 cycles less than 5% of the signal applied across the tone control reaches the grid. Note that a much smaller than usual condenser is used in this type of tone control.

While the usual tone control in discriminating between frequencies, divides the entire signal unfavorably, this tone control discriminates between frequencies without unfavorably dividing the signal.

Servicemen:—Do you find these analyses of current radio circuits useful in your work? Can you suggest any improvement in the way these analyses are made up?—Editor

COMING
10 BILLION TO 1

ANOTHER SENSATIONAL INSTRUMENT



From The Successful Servicing Laboratories of JOHN F. RIDER

A Really New Instrument. New in Design—New in Performance. Unequaled by any existing piece of equipment now available to the servicing field!—A device as sensational in performance as The Rider Chanalyst! Announcement of this new Rider instrument will be made in your favorite radio magazine. It will headline the news—be talked about wherever two servicemen get together—don't miss it.

This New Device WILL NOT Take the Place or Do the Work of The Rider CHANALYST

So—if you do not already own a Chanalyst get the facts on this proven instrument which will cut your trouble-shooting time to an absolute minimum. Find out how simple and easy it is to use the Chanalyst for the location of defects in receivers of all types and makes. Send for the new illustrated 80 page (8 1/2 x 11") book. Get the facts which will enable you to go to your jobbers and demonstrate the Chanalyst to yourself. Send the coupon at right NOW!

Don't buy any instrument until you have all the facts. Send coupon for complete story on

The RIDER CHANALYST

Service Instruments, Inc.
406 Fourth Ave., New York City
Enclosed find 25 cents (in stamps or coin) for the 80-page book completely explaining the Rider Chanalyst and True Dynamic Testing.

Name.....
Address.....

SERVICE INSTRUMENTS, INC.

404 Fourth Avenue, New York City
Foreign Division—147 W. 45th Street, N. Y., Cables—"Servicin"

Please Say That You Saw It in RADIO-CRAFT



they actually work **C-D Quietone**

RADIO INTERFERENCE FILTERS

Like all C-D products—Quietone Radio Interference Filters were checked and tested under exaggerated laboratory simulated operating conditions—before being introduced to the industry. That's why we can say with confidence—"They Actually Work."

Here's a really fine opportunity to make extra money. C-D Quietones are scientifically designed to do a job—attractively finished and supplied in three colors to match room interiors. With a Quietone designed for every application—and there are twelve types available now—they're really a cinch to sell. Demonstrate them to your customer when you are on a call—show them—they'll sell themselves.

For complete details on these and other Quietone units see your local C-D distributor or write for Cat. 166A.

- Type IF4—For use with midrange sets. List Price\$1.00
- Type IF5—For use with all types of electric razors and small appliances. List Price\$1.00
- Type IF6—For use with all types of electrical appliances. List Price \$1.50
- Type IF7—For use with oil burners. List Price\$7.50
- Type IF8—For use with all type receivers and electrical appliances. List Price\$4.95
- Type IF9—For use with all larger household and office appliances. List Price\$5.50

Product of the world's largest manufacturer of capacitors



CORNELL-DUBILIER ELECTRIC CORPORATION

1014 Hamilton Boulevard, South Plainfield, New Jersey
Cable Address: "CORDU"

A DOUBLE-BARREL OF EXTRA PROFIT FOR SERVICEMEN!

PHILCO TUBE CHECKER

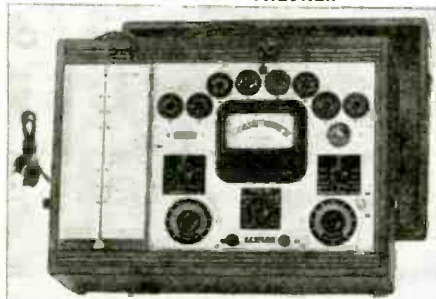

Brand New Model 066 Listed in Philco's 1938 Catalog at \$80.00. A modern, high-quality tube checker—gives absolutely dependable test because it applies a check that covers all the characteristics of the tube at once. Shows overall performance rating and conditions—as well as the actual output of the tube under the exact equivalent of broadcast receiving conditions.

Features—Tests Every Standard Tube Type, Actual Operating Voltages, Large Easy-reading meter, Neon Tube Short Test, Rectifier Diode Test, Solid Wood case & handle, For Counter or Portable Use, Complete Chart & Instructions. Dimensions 15 3/4" by 11 1/4" by 7 1/2". For AC Current only—60 cycles.

Now \$26.50 Complete in Portable Case with Hinge cover. All the charts.

ORDER DIRECT LIMITED QUANTITIES
THOR RADIO
60 Dey Street, New York City

WESTINGHOUSE 10-TUBE CHASSIS

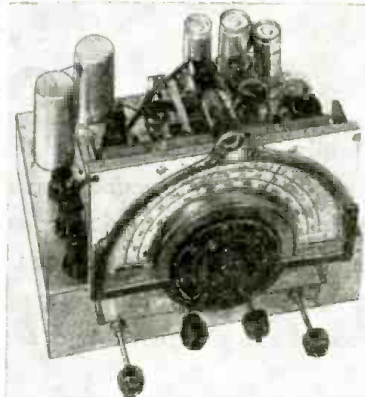

Westinghouse Model WR-321 10 Tube, All-Wave Chassis, tubes, speaker. Ideal for bookcase—fireplace, bar or period furniture mounting. Perfect for use as tuner or for phono-reproduction. 4 Audio Tubes deliver excellent frequency response. Three Band Tuning on 2 speed geared dial. Complete instructions and all mounting bolts. Features, Size 14" long, 13 1/2" high, 12 1/2" deep. Push Pull Output 10 watts, 12 inch dynamic sprk., tuned R.F. Stage 3-rank condenser. Pre-selection all 3 bands, covers 23 mcycles to 9.8, 12.6 mcycles to 4.3, 1800 kilocycles to 540. Built in Phono Connection, Electric Eye Indicator, A.V.C. & Tone Control, Tapped Transformer 105-250 volts, AC only. Tube Complement, 1-6K7, R.F.; 1-6A8, OSC; 1-6K7, I.F.; 1-6H6, Det.; 1-6F5, 1st Audio; 1-6CS, Inverter; 2-6X4, Push Pull; 1-5Y4-G, Rectifier; 1-6U5, Electric Eye.

Now \$34.50 Complete With 10 Tubes - 12" Sprk. Escutcheon - Instructions

ELECTRICITY FROM YOUR OWN ELECTRIC PLANT WHEN POWER LINES FAIL

ONAN A.C. ELECTRIC PLANTS supply current for Radios, Transmitters and Receivers, P. A. Systems, Movie Projectors, Sound Truck Amplifiers, Tools, Lights, All Appliances. Used as Standby Equipment in Schools, Hospitals, Theatres and Public Buildings in case of Power Line Failure due to Storms, Floods, etc. Available in 110 or 220 Volt A.C.—12, 32 and 110 Volt D.C.—Also Dual Voltage AC-DC Types. Manual, Pull Automatic & Self-Starting. \$99 and up. Shipped, Ready to Run.
D. W. ONAN & SONS
681 Rejelson Avenue Minneapolis, Minn.

MAKE YOUR OWN "TALKIES"!

With MILES newly patented "FILMGRAPH"—Instantaneous SOUND-ON-FILM RECORDER and REPRODUCER. No dark room nor processing required. Special models to make "TALKIES" in conjunction with cameras or SILENT as well as sound projectors. Also models for use with or without pictures. 84 minutes of recording (without pictures) may be had on 100 feet of 16 mm. film costing only 85 cents. Permanent play-back. Moderate initial cost of FILMGRAPH—only expense for putting SOUND ON FILM. MILES REPRODUCER CO., 812-RC6 Broadway, New York, N. Y.

AT LONG LAST—STATIC-FREE RADIO!

(Continued from page 588)

OTHER ADVANTAGES

The new system will do away with one of the most familiar figures in radio, the gain rider, who sits behind a soundproof glass panel and, watching the program, regulates a dial controlling the frequency of the sound going out over the microphone. Major Armstrong's invention because of the greatly increased dynamic range, which is the ability to reproduce both the loudest and softest tones with perfect fidelity and without noise, enables the sound being broadcast to remain even and natural without any distortion due to compression. (This is an impossibility with amplitude modulation, we understand.—Editor)

"The new frequency modulation differs from the amplitude modulated transmitter now in use in that the wave frequency broadcast by the improved method is changed in accordance with the fluctuations of the voice, and not the intensity of the radiation, as in the existing amplitude modulation method of broadcasting," Major Armstrong said.

"Frequency modulation programs will, at any given listening point within the range of the station, in general have from 1/100 to 1/1,000 the disturbance of programs broadcast by the present method," Major Armstrong pointed out. This means a much better reception within the service area for the new station, conservatively estimated at 100 miles. The receiver automatically rejects a signal that is too weak to be received satisfactorily, such as man-made or natural static noises, but receives all waves sent out from the high-powered transmitter. Selective fading, which causes musical instruments to produce strange noises and speech to become unintelligible, is non-existent in the new system, Major Armstrong added.

In addition to the advantages in sound production he said that the method could be used for multiplex sending, and that as many as 4 channels had been simultaneously transmitted and received by one transmitter and one receiver. The theory on which the system works is a direct reversal of that on which engineers have previously worked to eliminate noises. The principle has been to narrow down extraneous sounds, while the Armstrong system does just the opposite. It is the necessity of the wide band which makes it impractical at the wavelength now customarily used.

The fundamental principle consists in inducing into the transmitted wave a characteristic which does not exist in the waves produced by nature. The receiving system is not responsive to waves of natural origin but only to the waves having the special characteristics. (During the secret tests that were held while the invention was being developed, some amateurs became aware of what was going on and complained to the station being used in the Empire State Building that something was wrong with the transmitter.)

The invention was publicly demonstrated before the Institute of Radio Engineers in 1935. At that time a sound reel recording was played comparing the reception during a thunder storm of the old and new types of broadcasting. The recording was made from broadcasts received at a distance of 85 miles from the 2-kilowatt station in the Empire State Building using the new method, and from WEAJ, a 50-kilowatt station. While WEAJ came through strongly, its program was made unintelligible by crashes of static. In contrast, the frequency-

Please Say That You Saw It in RADIO-CRAFT

modulated signals from the Empire State Building provided an uninterrupted, clear program, free from static, despite the fact that its power was only 4 per cent that of the larger station.

"Great credit for the tremendous amount of development work necessary to perfect the high quality of the transmission must go to John Bose and James Day, two of my assistants. Apparatus for the station was designed in the Hartley research laboratories at Columbia University, where the most delicate parts were made. The remainder of the equipment was constructed at the Radio Engineers Laboratory in Long Island City and the RCA Manufacturing Company of Camden." Major Armstrong paid the highest tribute to the engineering skill of Mr. John Evans of the RCA Company, who designed the high-power equipment and to Perry H. Osborn, who assisted in the construction.

The new station, built at a cost of several hundred thousand dollars, is owned in its entirety by Major Armstrong. The construction went on in the face of a regulation of the Federal Communications Commission which, had the experiment not proved entirely successful, would have forced W2XMN to remain forever on an experimental basis. "The number of frequency modulated stations being constructed will no doubt lead to the consideration by the Commission of the question of granting commercial licenses," Major Armstrong said.

Major Armstrong first started to work on the problem of eliminating static from radio broadcasts in 1914 in collaboration with Professor Michael I. Pupin, after whom the Pupin Laboratories at Columbia are named. Both men gave up the problem in 1922, convinced that there was no solution. A year or two later Major Armstrong started to look for a solution from a new angle that eventually led to the present discovery.

MAKING A SHOP-TYPE A.C. TO D.C. POWER SUPPLY

(Continued from page 604)

the tip-jacks and, with the radio receiver to be tested turned on, advance the voltage regulator switch from low-voltage up the scale until a D.C. voltage corresponding to the voltage at the customer's home is attained.

NOTE—When through using the power pack, it is preferable to disconnect the A.C. supply first, thus allowing the condensers to discharge into the chassis under test. Rating of completed power supply: input, 300 W., A.C.; output, 2.5 A. at 115 V., D.C.

CORRECTION

In "Making A Serviceman's Test Unit, the 'Super-Geno-Scope,'" January '39 "R.-C.", pg. 409 (diagram, Fig. 2. of Super-Geno section), connections to R8 were shown reversed. See corrected detail, below.

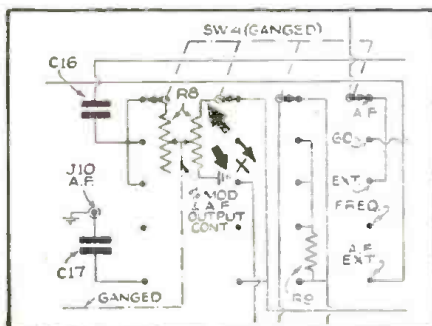

Now! ALLIED'S New Spring Catalog

Brings you everything new in Radio AT LOWEST PRICES

DEALERS • SERVICEMEN • AMATEURS • BUILDERS • SOUND SPECIALISTS

Get Your Copy Today!

Allied Radio 1939

NEW SETS!

Now in ALLIED's brand new Spring Catalog, see the new Knights, with Push-Button Tuning, "Air-Magnet" built-in aerials, newest features—at prices never before possible! 60 Models, some as low as \$6.95—AC, AC-DC, 1½ Volt, 6 Volt, 32 Volt, portable and auto sets—and radio's biggest line of Phono-Radios, phonographs, and record players! All backed by an ironclad guarantee! See many "specials"—"Pee Wees," "Magic Wireless" record players, etc. For real radio profits, send coupon now!

AIR-MAGNET RADIO

LOW-COST AUTO-RADIO

NEW P.A.

8 to 65 watts—standard and de luxe—permanent, portable and mobile—Monitor Speakers, Remote Control—also complete recording equipment, discs, accessories; read all about the new low-priced "Flex-disc"!

NEW AMATEUR GEAR!

HAMS! See all the new station-checking equipment to meet new FCC regulations: Rotary Beam Antenna gear, new Hallicrafters, National, Howard, R.M.E. models—all leading lines, at lowest prices! Everything for the Amateur!

NEW BUILDERS' KITS!

Dozens of new kits! Meissner 1, 2, 3 Tube Kits, "Pee-Wees," "Mystery" Phono, and Mike kit, Photo Cell, etc. Write for Free Parts Lists!

SEND FOR HANDBOOK

A new and different book, tells how to select circuits, read diagrams, build sets, etc. Packed with valuable data. Only 10¢—see coupon. Get your copy now!

NEW TESTERS!

New equipment with provision for new Loctal Tubes, etc.—all leading lines of tube checkers, set testers, analyzers, oscillographs, etc.—and over 14,000 parts at lowest prices, in ALLIED's new catalog!

ALLIED Radio Corporation

833 W. Jackson Blvd., Chicago, Ill.

() Send me your new FREE Radio Catalog for spring.

() Enclosed find 10¢ (plus 3¢ postage) for Radio Builders' Book.

Name

Address

City State

YOUR LAST OPPORTUNITY TO GET THIS FREE BOOK! Only a few copies of the 1938 RADIO REFERENCE ANNUAL are still available! It's the BIG, FREE BOOK of 64-pages you receive when you subscribe to RADIO-CRAFT. The ANNUAL covers set building, servicing, public address, test equipment, plus a number of other interesting topics. Send your remittance of One Dollar to RADIO-CRAFT, 99-R HUDSON STREET, New York, N. Y., and you will receive a subscription to RADIO-CRAFT for Seven Months, and your copy of the 1938 RADIO REFERENCE ANNUAL will be mailed postpaid immediately.

BRUSH'S VIBROMIKE

A contact mike—sensitive—small for stringed musical instruments. Useable with smallest type amplifiers.

Write for your Brush Catalog today.

THE BRUSH DEVELOPMENT COMPANY

3312 PERKINS AVENUE CLEVELAND, OHIO

SOLAR

MORE for your money

MINICAP

Catalog upon request

SOLAR MFG. CORP., 599 Broadway, New York

THE PIPELESS ORGAN

(Continued from page 594)

when it is used as an Antiphonal Organ.

The Cathedral Chimes used in the Organatron are of the conventional tube type. They are suspended in chromatic order from A to E, 20 notes, in the chime cabinet as shown in Fig. E. The contacts for operating the chime solenoids are located under the Great keyboard, and are adjusted so that the chimes will speak at the same depth of key depression as do the various Great Organ tonalities. The chimes used are of the finest grade with a uniform wall thickness and a diameter of 1 1/4 ins. They are either nickel-plated or luster gold finished. On the console is placed a 3-way intensity switch, allowing the chimes to be played at *soft*, *medium* and *loud*. This is accomplished merely by reducing the voltages for each of the above mentioned intensities.

Figure 3 shows the main Tone Chamber, made up of its various components.

Figure C shows the Booster Tone Chamber. The speaker set-up is identical to that shown in Fig. B (Part I) for the regular Tone Chamber. The Booster Tone Chamber has an independently energized amplifier, and when added to an installation increases the output power approximately 30 watts. More than one Booster Tone Chamber can be added for additional coverage.

By "voicing," as referred to in Part I, we mean adjusting or bending the unrestricted end of the vibrator to change the harmonic content of such vibrator in order to produce different qualities of tone. This method of voicing the Organatron reeds is very similar to that employed in the pipe organs. In the pipe organ, voicing is done by (a) the nicking of the languid, (b) adjustment of the languid and (c) the adjustment of the upper lip of the pipe. Voicing as we use the term may be more simply defined by stating that it is the act of qualifying the reed in order to obtain a particular character of tone.

The Master Schematic of the Organatron is shown on pages 594 and 595. This you will observe shows the output circuits of the main Tone Chamber and the Echo Organ, and part of the Chime layout which is further shown in Fig. E.

The organ, though it be evolutionized, is still a tribute to the craftsman in mechanics, the artist in wood and metal, the scientist in the field of electricity, and the inventor and practical builder. (The Organatron, invented by Frederick Albert Hoschke, is covered by the following patents: U.S.—No. 2,015,014, No. 2,062,515; Gt. Britain—No. 451,798; France—No. 788,330; Belgium—No. 408,857.—Editor)

It may be well to here mention the difference between the Antiphonal and Processional divisions of the Organatron. While these 2 tone chambers are identical in appearance, their difference lies only in their placement throughout the building in which the instrument is installed.

The *Antiphonal tone chamber* of the Organatron is, without exception, placed on opposite sides of church chancels so that you can accomplish responsive playing; that is, back and forth from one Antiphonal unit to the main organ, or to a second Antiphonal unit.

The *Processional organ* (or tone chamber) is so located and placed to accompany the church or auditorium choir during its procession.

Some of these units are placed in the hallway leading from the choir room to the nave or chancel of the church. Its purpose, of course, is to keep the choir amply supported while marching on its way into the church proper. As soon as all of the choir members have entered into the church

proper, the organist ceases playing the Processional organ and commences playing the sections of the instrument in the church so placed for hymn and anthem singing.

It is to be understood that either Antiphonal, Processional or Echo tone chambers can be operated independently or played simultaneously with the standard tone chamber units.

Correction: Referring to the diagram, on page 594, marked "Amplifier," note that the correct capacity for the 400-V. coupling condenser, between the plates of the first three 6F5 tubes and the grid of the following 6F5 tubes in the amplifier, is 0.025-mf. instead of the figure (1025 mmf.) indicated.

Radio-Craft has been advised by Mr. Benjamin F. Miessner that this instrument, like practically every other electronic music

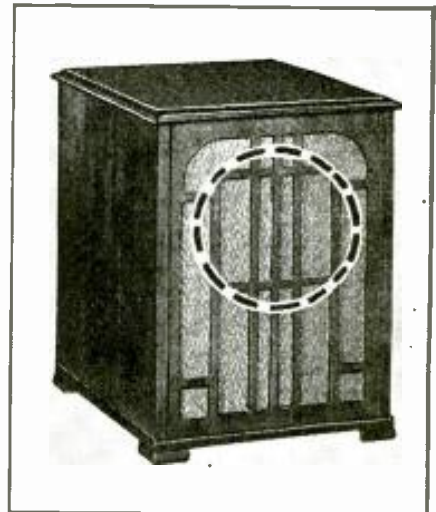

ECHO CHAMBER

Fig. D. The Echo Chamber unit may be used not only to supply echoes for simulating the tonal effects of very large rooms, but also may be used in the two additional services of Antiphonal and Processional Organ effects.

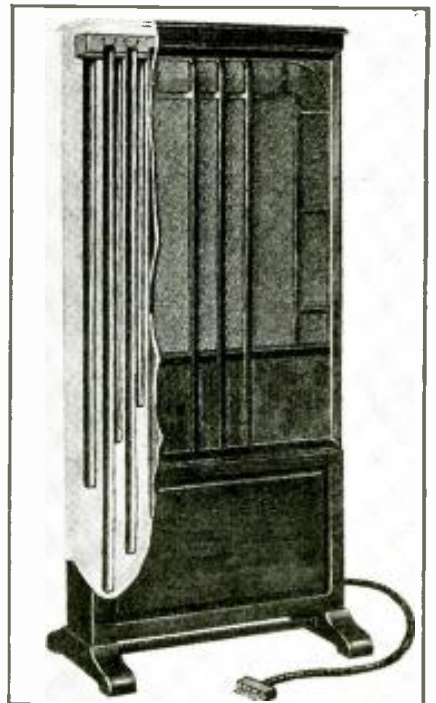

CATHEDRAL CHIMES

Fig. E. The Cathedral Chimes unit consists of 20 tubes, suspended in chromatic order from A to E, within a grided cabinet as shown.



Old Man Centralab took his baptism in a furnace at 2500 F.

He laughs at such temperatures as 200 degrees . . . the sort of heat he has to take sometimes when he is parked near a ballast resistor or a transformer in a radio receiver.

Even where chassis temperatures ARE elevated the Centralab resistor, with its complete ceramic construction baked at 2500 degrees, laughs at a mere 200 degrees. Where ordinary fixed resistors break down under temperatures of 200 or even less, Centralab is positively unaffected.

Join the thousands of Centralab addicts . . . specify Centralab for original equipment or replacements.



CENTRALAB: Div. of Globe-Union, Inc. MILWAUKEE, WISCONSIN

Centralab

(MILWAUKEE WISCONSIN)

FIXED RESISTORS



•There's
Another Man
waiting
for YOUR Job!

It's your job today—to train for a better job tomorrow!

● The Radio Industry is crammed with "pretty good" men . . . that's why your boss can afford to be "choosy" in selecting men for better jobs. He knows that there is always another man waiting for your job . . . but, DO YOU? Right now is the time to insure your future in Radio. You must be technically trained to hold and improve your present position. There's always room at the top for men who can produce. Our story is vital to your future and the success of every Radioman—send for it today.



CAPITOL RADIO Engineering Institute

MAIL THIS COUPON TODAY!

CAPITOL RADIO ENGINEERING INSTITUTE
Dept. RC4, 3224 16th St., N.W., Washington, D.C.
Please send me a personal copy of the new illustrated 48-page booklet—"A Tested Plan for a Future in PRACTICAL RADIO ENGINEERING."

Name
Address
City RC-4

Please Say That You Saw It in RADIO-CRAFT

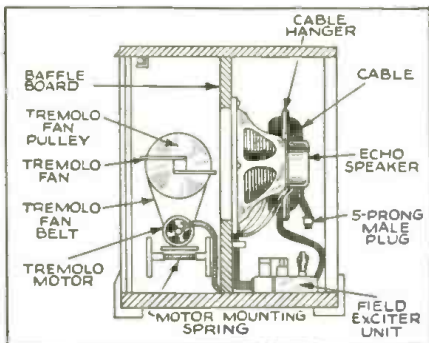

Fig. 2. Cross-section view of the Echo Tone Chamber. Consists of speaker, field current supply and motor-driven sound shutter for getting tremolo effects.

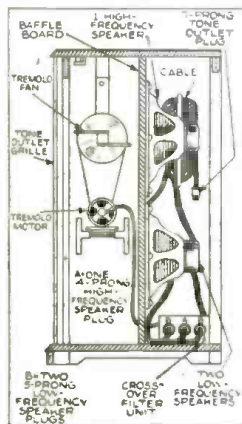

Fig. 3. Cross-section of the Tone Chamber showing 2 of its 3 speakers and the motor-driven sound shutter for producing tremolo effects. A similar chamber with a self-contained amplifier is called a Booster Tone Chamber.

instrument now manufactured in this country, is based very largely on the inventions of Benjamin F. Miessner and his Millburn, New Jersey, Laboratory group.

He now holds nearly 40 issued patents (and many pending) in this field, in the U. S. alone. Over 20 manufacturers, including the Everett Piano Co., are now operating as licensees under these patents in this and foreign countries. Among these licensees also are the Krakauer, Ansley, and Hammond companies, whose electronic instruments have been previously illustrated and described in *Radio-Craft*.

Mr. Miessner will be remembered for his pioneer work since 1911 on radio torpedo control, aircraft radio, electrical phonography, and particularly for his work on A.C. sets and tubes, and battery and hum elimination.

Electronic music is rapidly forging ahead, and foresighted radio men will see to it that they "get in on the ground floor" by absorbing every bit of available information on this interesting subject. Radiomen who have, in addition, some grounding in the fundamentals of music appreciation will go further than technicians who are unable to talk the language of musicians.

By courtesy of Mr. Miessner *Radio-Craft* calls attention to the following articles on electronic music, in addition to the many articles on the subject that have appeared in "R.-C.", of interest to the field.

The Music Trade Review, Dec., 1937: "Electronic Piano the Natural Move Forward in Harmony with Developments in Other Fields"; *Proc.*, Radio Club of America, Jan. 1934: "The Application of Electronics to the Piano"; *Proc.*, Inst. of Radio Engineers, Nov., 1936: "Electronic Music and Instruments"; *Journal*, Acoustical Society of America, Jan., 1935: "The Design Considerations for a Simple and Versatile Electronic Music Instrument"; *Atlantic Monthly*, Jan., 1935: "New Horizons in Music" (by Leopold Stokowski).

This article has been prepared from data supplied by courtesy of Everett Piano Co., Orgatron Division; except for the above correspondence of Mr. Miessner.

THE PORTABLE LAB

that gives you EVERYTHING!

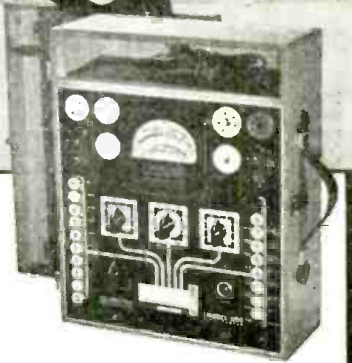

SUPREME 504 TUBE and SET TESTER

» » » QUICK FACTS « « «

- Complete, modern tube tester and set tester with total of 31 ranges and functions.
- "Arrow-Way" tube testing using fast tester with total of 31 ranges and functions.
- Correctly checks all tubes—including "7," "1.4," "35," "50," "S" (single end tubes) series, locals, octals, non-octals, "G," "MG," "M," "GT" types, gaseous rectifiers, magic eyes, ballast tubes, pilot lights.
- Tests tubes 7 ways (1) open filaments, (2) "hot" leakage cathode test, (3) super-sensitive "hot" anode leakage test, (4) shorts, (5) opens, (6) overall quality, (7) separate section and plate quality test. Only a good tube will pass.
- Tests made at proper applied anode voltages and rated load for all tube types.
- Only six sockets required for all present and future tubes. No additional instructions necessary on the tube chart. You can't place a tube in the wrong socket.
- Patented SUPREME "double floating" Filament Return Selector Push Button System banishes obsolescence. Let filament positions on future tubes change to any possible arrangement—to take care of such changes all you do is PRESS A BUTTON.
- Tapped transformer secondary supplies all CORRECT heater and filament voltages.
- "Speed-Way" push button multimeter circuit. Two rows of push buttons control 31 basic ranges and functions.
- 0.1 to 2500 D.C. Volts.
- 7 ranges of 0.75/25/100/250/500/1000/2500.
- 0.1 to 1400 A.C. Volts.
- 5 ranges of 0.75/10/50/250/1000.
- 10 Microamperes to 10 Amperes. 7 ranges of 0.500 microamperes/2.5/10/50/250 milliamperes/1/10 amperes D.C.

- 0.1 to 1000 Output Volts. 5 ranges of 0.75/10/50/250/1000.
- 0.1 to 20 Megohms. 3.5 Ohm Center Scale. 5 ranges of 0.7/200/2M/20M/2 Meg/20 Meg. Self-contained power supply.
- All electrostatic capacitors checked for leakage up to 20 megohms on meter.
- All electrolytics including high voltage filter capacitors and low voltage—high capacity bypass capacitors, checked at working voltages.
- 7 individual working voltages of 450, 300, 250, 200, 100, 50 and 25 volts.
- Settings are given for each capacity and working voltage on roller chart and tests made on a "Good Capacitor—Bad Capacitor" English reading scale.
- All ranges except D.C. 2500 volt and 10 amps. operate from but one set of pin jacks.
- New "Permi-grad" temperature compensated A.C. voltmeter circuit with full rectifier protection. Rectifier guaranteed with instrument.
- 4" x 4 1/4" 500 microampere meter built by Westinghouse—oversize solid forged magnet with welded pole pieces built to United States Navy standards—a life-time meter.
- All multimeter ranges factory calibrated to within 2% on D.C. and 3% on A.C.
- Individually, specially selected and aged ceramic resistors used for all voltmeter ranges. Wire wound resistors in all current ranges.
- May be purchased on easy payments—just a few cents a day, no more than the cost of your cigarettes.

CASH PRICE \$55.50
 Installation terms \$5.09 cash and 11 payments of \$5.09.

SUPREME

SUPREME INSTRUMENTS CORP.
 GREENWOOD, MISSISSIPPI, U. S. A.

EXPORT DEPT., Associated Exporters Co., 145 W. 45th Street, New York
 Cable Address: LOPREH. N. Y.

MAIL COUPON TODAY!

SUPREME INSTRUMENTS CORP., Dept. C.3,
 Greenwood, Miss.
 Please RUSH me your newest information on SUPREME
 504 and 6 other brand new SUPREME Instruments.
 Name: _____
 Address: _____
 City: _____ State: _____

GET A REAL ELECTRO PLATING KIT ABSOLUTELY FREE!

Complete details as to how it is possible to get a Real Electro Plating Kit FREE, appears on Page 637 of this issue. TURN TO IT NOW!

ELECTRICALLY RECORDED RECORDS



SAVE MONEY
 ON ALL BRANDS OF
 PHONOGRAPH RECORDS

We have an exceptionally large variety of standard records (play both sides) played by popular artists. Records of hot dance numbers, vocal, waltzes, instrumental, old-timers, hill-billy, etc., are available. WRITE TODAY FOR RECORD CATALOG.

FREE GIANT RADIO CATALOG for Dealers. Service Men and Experimenters is NOW READY! Send postcard today for yours.

UNITED RADIO COMPANY
 Dept. R-1000, Newark, N. J.

YOUR FUTURE IN RADIO TELEVISION

• These growing industries need trained men for sales, service, operation. Your chance for employment and advancement depends on thorough training. National Schools offer you time-tested training. Complete, modern facilities and equipment in the largest trade school in the West. Established 1905.

Send for free booklet that shows how you can prepare for these opportunities.



NATIONAL SCHOOLS
 4000 S. Figueroa Street, Los Angeles

NATIONAL SCHOOLS, Dept. "RC" Los Angeles
 Please send free Radio and Television Booklet:
 NAME _____ AGE _____
 ADDRESS _____
 CITY _____ STATE _____

Please Say That You Saw It in RADIO-CRAFT

Yours Free! SIMPSON TUBE TESTER

BUY ONLY 19 NATIONAL UNION TUBES AND/OR ELECTROLYTIC CONDENSERS PER MONTH - ASK YOUR N. U. JOBBER

It's a little beauty, this new Simpson Tester! Light weight, small size, compact, great big easy reading meter. Just the kind of instrument you need for all 'round work. In addition to tubes, it tests pilot lamps, Christmas tree bulbs, ballasts, gas rectifiers. Tests for noise and shorts.

For complete technical data consult your National Union jobber. He's ready to GIVE YOU one of these testers on an amazingly attractive N.U. offer. Small deposit refunded as merchandise credit when your contract is complete. Get details NOW!

TESTS SINGLE ENDED - LOKTAL TUBES
... let your N.U. Jobber GIVE YOU one of these new SIMPSONS!



Come on!
BUILD CUSTOMER CONFIDENCE WITH N.U. TUBES and CONDENSERS

NATIONAL UNION RADIO CORP.
Newark, New Jersey

Who is nearest Nat. Union Jobber?

Name

Street

City..... State.....

RC-439

Be a RADIO EXPERT - Learn AT HOME

RADIO SPECIALISTS NEEDED

Modern receivers with their complicated circuit systems have knocked out the old time cut-and-try radio fixer. Trained men with up-to-the-minute knowledge are needed to service these new sets.

HERE IS YOUR OPPORTUNITY

Your possibilities of making money and getting ahead are limited only by your ability and skill—but you must know more than the other fellow. You must be a radio service specialist, as R.T.A. can train you.



PRACTICAL TRAINING AT HOME

Our home study course is practical "shop and bench" training combined with a thorough set of practical lessons prepared by an experienced Radio service engineer. Four working outfits are also furnished.

MAKE SPARE TIME MONEY

Our training is complete and practical. We show you how to make money almost from the start. The course can easily be made to pay its own way. Investigate now, write for free book of details.

WHAT R.T.A. STUDENTS SAY

Norwood, Ohio
I have connected with a large firm as Radio Service Manager and wish to extend my thanks for your help.

Joseph Radlen, Jr.

Yorkville, Ohio
From Aug. 1 to Dec. 7, 1936, I repaired 163 radios and put up 43 aerials which is very good for part time work while studying your course.

Chat. Koerber.

RADIO TRAINING ASS'N OF AMERICA
Dept RC-49, 4525 RAVENSWOOD AVE., CHICAGO

Now!

BALLAST REPLACEMENT

made AMAZINGLY SIMPLE!

Only 4 standard types of Amperite AC-DC Regulators will replace 90% (over 100 types) of AC-DC Ballast Tubes now in use!

WRITE FOR CHART AR.

New Low Price \$1.00 List

AMPERITE Co. 361 BROADWAY, N. Y.

AMPERITE AUTOMATIC REGULATORS

Print Your Own

Cards, Stationery, Advertising, labels, paper, circulars, tags, etc. Save money and time. Sold direct from factory only. Junior outfit \$8.25, Senior outfit \$17 and up. Do popular raised printing like engraving with any of our presses. **Print for Others, Big Profits** Pays for itself in a short time. Easy rules sent. Write for free catalog of outfits and all details. Kelsey Presses N-97, Meriden, Conn.

EXCELSIOR

LOOK WHAT

a 3c. stamp will bring you, - - -

our new complete catalog on dry electrolytic and paper condensers, also a sample of hermetically sealed paper condenser.

Write today. - - give your jobbers name.

ILLINOIS CONDENSER CO.

1160 N. Howe Street Chicago, Illinois

PATENTS—TRADE MARKS

All cases submitted given personal attention by members of the firm.

Form "Evidence of Conception" with instructions for use and "Schedule of Government and Attorneys Fees"—Free

LANCASTER, ALLWINE & ROMMEL

PATENT LAW OFFICES
436 Bowen Bldg. Washington, D. C.

WE HAVE The RADIO YOU WANT

Our 1939 catalog is chock full of new Standard Brand Radios for Home-Farm Auto. Over 400 models. Also hundreds of Electric Appliances for the home. Celebrating our 50th Anniversary with Big Bargains. Write for your copy today. It's FREE.

MODELL'S Dept. 57 Cortland St., N.Y.C.

SIMPLE TECHNIQUE FOR MAKING HOME TALKIES

(Continued from page 603)

"synched" record of the same. Synchronizing or matching "start marks" punched in both films before shooting would provide synched projection as discussed later herein.

Methods of technique for obtaining the best results in an easy manner have been discussed earlier. If one does not desire to convert his present camera to A.C. operation he may exchange it for another type electrically operated and long since marketed by leading manufacturers such as Bell & Howell or Victor Animotigraph.

FILM PLAYBACK

With the two films at hand, one bearing "pix" (pictures) and the other sound, we have two methods permitting the projection of a combined Sound Movie Show.

Method 1:—An extended and keyed axle-shaft for the projector take-up reel may replace the original short shaft. We may then securely lock alongside the picture take-up reel the similar reel of the film-indenting unit converted for playback. If the two films be threaded up with respect for the previously punched "start marks"—threaded so that when a picture passes its aperture in the projector, its corresponding sound passes under the playback needle—we obtain a synchronous show.

Method 2:—By means of a second recording unit of the same type (one to be used for recording while the other is used for playback) we might re-record from the original film track or record to the back of the picture print. That would net us a combined sound and pix print on one roll of film. Naturally then, we could set up the playback in series with the projector as we did for a combined show after Scoring.

After such a re-recording the original sound film would not merely be waste, when replaced by the combined print, for it would still have room for 20 or more other recordings on its same surface!

Of course rented films or those bearing variable light tracks may be projected through any conventional sound projector. An endless variety of subjects are available with which you may build up the entertainment value of your home talkie programs. It is helpful to study these professionally-made films and compare them to your own efforts. They may be had from such as the following:—Kodascope Library (Eastman), N. Y. City. Willoughby Camera Shop (film library both 16 & 35 mm.), N. Y. City.

CONCLUSION (FILM)

Incidentally your own voice will never sound natural to you although it will to others. The explanation is simple. We hear a complex tone while we speak. If we completely plug up both ears and talk normally, we still hear ourselves talking because of our auditory nerves and our sense of hearing. Normally, unless very deaf, we hear that inner auditory interpretation combined with that sound which travels outwardly from our mouth to our ears. We therefore consider our own voice to be something entirely different from and foreign to, that which other people know it or a microphone perceives it to be.

Conventional high-impedance telephones (headphones) may be plugged across some suitable low-level point to serve for monitoring while recordings are being made. The playback itself is the better and final check of the record.

Please Say That You Saw It in RADIO-CRAFT

RADIO WEATHER STATION—1 MILE UP!

(Continued from page 587)

At the present time 3 transmitters are in operation. The one used for communication with the Civil Aeronautics Authority Radio Station at Albany Airport is a standard Collins 45A unit with approximately 125 watts C.W. output or 40 watts grid-modulated phone output. Continuous wave (C.W.) operation is used for several reasons. First, because it is more effective in the transmission of coded weather reports of the "jumbled jargon" type used by the Weather Bureau. Secondly, C.W. gets through better during periods of intense static conditions. Frequently, atmospheric interference—QRN—is so bad that the meters on the receiver are swung off scale.

The auxiliary transmitter is a Lafayette Model 5B, complete with modulator and antenna coupling units. A power of 40 watts on phone or C.W. is available from an RK37 final amplifier. The built-in oscilloscope proves very useful for monitoring. Coils are available for 5-, 10-, 20-, 40-, and 80-meter bands. This rig is used for amateur work mostly on 40 and 80 meters.

The third transmitter is a built-up rig running about 100 watts input on 59 mc., for communication with the Mt. Washington Observatory in New Hampshire and Rensselaer Polytechnic Institute in Troy. Both circuits are over 100 miles in length, airline, yet no difficulty is experienced. At times when fading occurs over the regular 4797.5 kc. channel, this circuit is not affected. A National 1-10 receiver is used for this ultra-high frequency reception. Signals from W2CDC in Troy, as well as W1XOY on Mt. Washington are strong enough to be received on a loudspeaker with this receiver.

For those who doubt this, I would suggest writing to Elbert F. Corwin, Rensselaer Polytechnic Institute, Troy, N. Y., the Managing Director, for permission; and then with the aid of snowshoes and ice creepers, climb up

the 5 miles of snow and ice to the top of Whiteface and see for yourselves.

Last Winter an experiment was carried on with Mt. Washington to determine the relationship between the change of signal strength of an ultra-high frequency beamed signal with the change of moisture content in the air. Equipment for this experiment included a superhet. receiver on 41 mc., with a line voltage stabilizer, and a sensitive recording galvanometer (Leeds and Northrup Micromax Recorder). The galvanometer was standardized against a local oscillator, so that qualitative material could be obtained.

The regular receiver is a National HRO mounted in a relay rack with coils from 175 kc. to 30 mc. The flexibility of the HRO is very helpful because of the numerous schedules maintained by Mt. Whiteface with stations ranging over this frequency spectrum. Yes, even the broadcast band is used, for the Winter nights are long and lonely for the 3 men stationed on the mountaintop.

Willard I. Cody is in charge at the Observatory. He was formerly engineer at WNBZ, Saranac Lake. Bertrand F. Lee is the U. S. Airway Weather Observer, formerly a radio operator on one of the Pan American clipper ships operating between Florida and Trinidad, South America. Both men act in two capacities, that of weather observing and reporting; and as radio operators. They also have to maintain all equipment. Both operators are very much interested in ultra-high frequency transmission and reception, as well as television. Besides the 2 operators, the Observatory also has a cook, Arthur Landers, who for many years was an Adirondack guide.

It is hoped that Mt. Whiteface will be able to cooperate in the near future with various agencies along this line of endeavor. A new medium-power transmitter for ultra-high frequency work is now under construction.

OPERATING NOTES

(Continued from page 608)

tioning normally. Excepting the case where the trouble is a defective 6T5 tube, the trouble is usually caused by an open 1 meg., ¼-watt carbon resistor located inside the target tube socket housing and connected between target and plate. Check for this trouble by testing for voltage on the plate of the 6T5 with a signal tuned in.

OSCAR CARLSON,
Park Radio Center

A.C.-D.C. SETS

When checking A.C.-D.C. midgets for distortion, check the coupling condenser by the use of a 25,000 ohms/volt meter or a vacuum tube voltmeter from the grid of the output tube to ground.

If condenser is leaky a minute, voltage will be present on the grid. A 1,000 ohms/volt meter isn't sensitive enough for this purpose.

II. C. BUCK

FILTER CONDENSER AND RECTIFIER TUBE FAILURE IN A.C.-D.C. RECEIVERS

There is a tendency for filter condensers and the rectifier tubes in A.C.-D.C. receivers to fail prematurely. Our Engineering Department has investigated this condition in collaboration with the manufacturers of the tubes and the electrolytic condensers and has developed a simple remedy.

It has been found that all makes of A.C.-D.C. receivers are more or less

subject to this trouble which is due to a peculiar power line condition. This difficulty is not due to high line voltages nor is it due to any fault in either the tube or the condenser.

With certain line impedances, it has been found that extremely high surge voltages are developed across the filter condenser, and as a result the condenser will puncture and thus this causes the rectifier tube to fail. The instantaneous surge voltages which are developed may be as high as 300 volts, and occur only if the set happens to be turned off on a particular part of the cycle!

Since this difficulty is due to a power line condition, it is very likely to happen repeatedly in any one location. In other words, if it happens once in a certain customer's home, it is very likely to happen again!

The remedy for this trouble is to connect an inexpensive 50-ohm, 1-watt resistor in series with the connection from the rectifier tube cathodes to the electrolytic filter condensers.

It is our suggestion that Servicemen install such a resistor in all A.C.-D.C. sets which come in to them for repair with either the rectifier tube or the electrolytic condenser requiring replacement.

STEWART-WARNER CORPORATION
J. N. GOLTEN
Service Department

FLASH!

YOU CAN TEST NEW "LOKTAL" TYPE TUBES WITH RCA TUBE TESTER!

From now on, all RCA Tube Testers will have this feature included at no extra cost!



Also available for
Portable use as Stock
No. 156... \$39.95

COSTS ONLY
\$37.95
NET
Stock No. 156-A

Only the RCA Tube Tester offers all these fine features!

1. Tests new 1½ volt battery tubes.
2. Tests every standard type of receiving tube including "Loktal" base and all ballast tubes. Also tests cathode ray tubes for shorts and emission. All tests made according to RMA standards.
3. Tests four prong and octal base ballast tubes for noisy welds and opens.
4. Tests Magic Eye tubes for brilliance and opening and closing of eye.
5. Tests voltage drop on all types of Gas Tubes, such as OA4-G, OZ4-G, 874 and others.
6. Easily operated. All operating instructions and settings shown on simplified roller chart.
7. One Finger Operation. Buttons released or retained automatically as required for testing.
8. Shows line voltage up to instant of actual test. Not necessary to set line voltage before inserting tube in socket.

If you now own an RCA Tube Tester you can test "Loktal" types—here's how!

Because RCA is aware of the fact that many present owners of the Tube Testers will want to test the new "Loktal" type tubes, an adaptor (illustrated) has been built for connection to the Tube Tester. Costs only 50c net (Stock No. 9858).



Over 325 million RCA radio tubes have been purchased by radio users...in tubes, as in parts and test equipment, it pays to go RCA ALL THE WAY.



Test Equipment

RCA Manufacturing Co., Inc., Camden, N. J.
A Service of the Radio Corporation of America

RCA presents the Magic Key every Sunday, 2 to 3 P. M., E.S.T., on the NBC Blue Network.

Please Say That You Saw It in RADIO-CRAFT



Radio is a "cinch"—when you use Ghirardi! He'll give you a complete radio education in just 1 handy volume. A miracle of condensation—for it gives you a sound and thorough training in RADIO, electricity, sound, television, cathode-ray tubes, etc. Everything you want is right here. Yet it's the quickest, simplest, easiest home-study course you could pick. No "math" puzzles you. No preliminary knowledge necessary. Just spend your spare time each day with the book. Before you know it, you'll find yourself qualified to hold down a good-paying radio job.

HERE'S WHAT YOU GET:

- Sound—Electrical Theory and Principles—Electrical Currents
- Electro-magnetism—Transformers—Inductance—Condensers—Measuring Instruments—Radioactivity—Broadcasting—Receiving—Vacuum Tubes—Amplification—Superheterodyne—Speakers—Receivers of all types
- Short-Wave—Auto-Radio—Aircraft Radio—Public Address—Photoelectric Cells—Cathode-Ray Tubes—Television
- Testing and Service
- Sound Motion Pictures—Reference Tables
- Radio schools and students use this more than any other radio book in the world.
- Will it work for YOU? YES!—send for it a n d t r y it right n o w —with the coupon below.
- You don't risk a cent! Get set to go!

\$4



RADIO PHYSICS COURSE

MAIL NOW

RADIO & TECHNICAL PUBLISHING CO.,
 45 Astor Place, New York, Dept. RC-43
 I have in \$4.00 (foreign) for my copy of RADIO PHYSICS COURSE. Payment enclosed at once with money-back guarantee.

NAME _____ STATE _____
 ADDRESS _____ 972 Pages. 508 Illus.
 CITY _____ Please send free descriptive literature.
 856 Review Questions

RADIO ENGINEERING



RCA Institutes offer an intensive course of high standard embracing all Phases of Radio and Television. Practical training with modern equipment at New York and Chicago schools. Also specialized courses and Home Study Courses under "No obligation" plan. Catalog Dept. RT-39.

RCA INSTITUTES, Inc.

A Radio Corporation of America Service
 75 Varick St., New York 1134 Merchandise Mart, Chicago

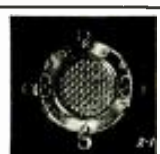

UNIVERSAL Heavy Duty Single Button Microphone
 Superlative performance. Low cost. Rugged, dependable. For voice pickup, p.a., amateurs, etc. Standard impedance, 200 ohms. Output level -50 db.

UNIVERSAL MICROPHONE CO., LTD.
 424 Warren Lane, Inglewood, Calif.

DO NOT FAIL

to read the important announcement which appears on page 580 of this issue. It is important news to everyone who is in the radio business.

A HOME-MADE STRING-MUSIC PICKUP

(Continued from page 601)

one is suspended from the South pole of the other.

CORE STEELS

The experimenter may wish to try other types of core material than hacksaw blades. The steel should be hard and of good magnetic quality, that is of such nature that it will retain magnetism over a long period of time. It is easy to try pieces of different steel by magnetizing them as described above and testing to see if they retain their magnetism.

When working hard steel it will be necessary to first anneal it by heating to a cherry red and covering it with charcoal or ashes so that it will cool very slowly. After the pieces have been cut to the desired shape, they may be re-hardened by heating to a dull red and plunging quickly in water. The author has found that flat tool steel makes excellent core material but it is not so readily obtainable as are old hacksaw blades.

It is well to note here that some hacksaw blades have tempered teeth and soft hacks, and if hard blades are not obtainable it will be necessary to temper the whole section after it has been shaped.

WINDING JIG

The details of the winding form (or jig) are shown at Figs. 1D and 1E. Cut 2 pieces of sheet metal, No. 14 to 20 gauge, to the size and shape shown at Fig. 1D. Drill a hole through the center of each piece to allow winding crank to slip through. Since the wire used in winding the coils is very small and easily broken, it is advisable to bend the corners of the metal sides outward to avoid the wire catching at those points.

Now bend a short piece of round metal rod, 3/16-in. in diameter to the shape shown at Fig. 1E, and thread one end. Place the core in the form so that it is parallel with the long side of the metal plate, with a piece of waxed paper in between the core and each metal plate, and bolt the whole tightly together, as shown at Fig. 1E. Wrap a strip of thin cardboard around the core and fill the corners between the sides of the form and the cardboard with paraffin so that there will be no possibility of the small wire slipping down between the core and the side of the form. Fold the edges of the waxed paper over the outside of the form and hold it in place with pieces of gummed paper.

For the coil windings approximately 1 ounce of No. 36 or 38 enameled wire will be required for each coil. This wire may be obtained from the secondary of an old ignition coil. (Remove the primary coil and all of the insulating compound from the secondary, also layers of insulating paper over the secondary coil so that the wire will unwind freely.)

Place the threaded end of the winding form in a small piece of pipe held in a vise, so that the crank will turn freely. Wrap several turns of the ignition-coil secondary wire around the form, bring the end of the wire over the form and secure it to the winding crank. Place a round rod through the secondary coil and begin the winding by turning the crank slowly.

Do not attempt to hurry the winding job and you will be repaid by having the coil in one piece. Since the wire is extremely small, any unusual strain on the wire will cause it to break. When approaching the end of each layer of wire on the ignition-coil secondary, it is advisable to stop winding and remove the strip of paper at the end of each layer. If a break occurs in the

wire, the ends of the wire should be carefully scraped with fine sandpaper, then twisted together and soldered, using rosin (only, no acid) as a flux.

In winding the coil there will be a tendency for the wire to pack tightly at the ends of the coil and wind loosely between the ends or along the sides of the coil, which if not corrected would cause the coil to spread out on the sides and prevent the proper amount of wire from going on the core. If during the winding operations the wire on the sides of the coil is pushed down frequently with a strip of stiff cardboard, the coil will be the same depth all around. The coil should be wound to a depth of 1/2-in. and if a mark is placed inside the form before the winding is started it will be easy to determine when the required depth is reached.

When the winding is completed, melted paraffin should be poured over the winding. When the coil has cooled, trim the waxed paper even with edges of the winding form and remove the coil by taking the sides

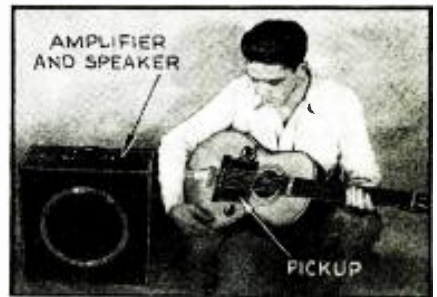

Every orchestra should have at least one electronic music instrument in its ensemble. Mr. Kendall Ford's unique pickup may be used with any steel-stringed instrument.

of the form apart. The waxed paper may now be trimmed even with the coil, taking care not to cut the coil ends. Two coils will be required and each should be wound in the same direction.

COIL FRAME

The frame for the coil case is made from a section of an old radio panel, either hard rubber or bakelite, 3/16- or 1/4-in. thick, cut to the size and shape shown at Fig. 1G. If a series of holes are drilled around the inside edge, the center may be easily removed with a hacksaw or coping saw. Drill and tap holes around frame, as shown at Fig. 1G. Provide terminal screws at end of frame, as shown at Figs. 1G and 1H.

Cut a bottom plate to the size shown at Fig. 11. Cardboard or thin fibre may be used for this plate, but metal is recommended on account of the possibility of other materials warping when hot insulating wax is poured over the coils. If metal is used, it must be non-magnetic such as brass, copper, zinc or aluminum. Drill 1/8-in. holes in bottom plate where indicated.

Make a top cover from fibre or cardboard and drill as shown at Fig. 1J.

You are now ready to secure the bottom plate to the frame (with No. 4-40 flat-head machine screws) and to place the coils in the case. A North and a South pole of the core must be opposite, and the windings must be in opposite directions, as shown at Fig. K.

Before making permanent connections it is advisable to try out the pickup for maximum response by connecting it to an amplifier. If the coils have been connected

Please Say That You Saw It in RADIO-CRAFT

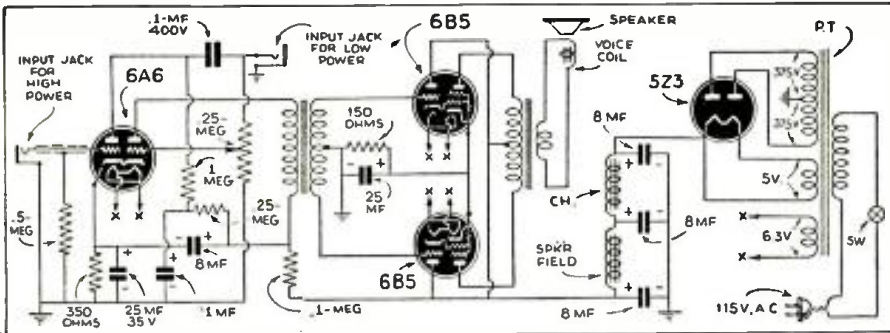

Fig. 2. Any high-gain amplifier may be used with Ford's pickup; or make an amplifier as shown above.

improperly it will be a simple matter to change the coil connections. Once this matter has been settled, you are ready to make a permanent soldered connection between the coils, and to solder the remaining ends to the terminal screws.

Melt the insulating compound that was salvaged from the ignition coil and pour it around the pickup coils. If the compound is allowed to flow around the coils and not over them, it will be a simple matter to remove the core, if it ever becomes necessary to remagnetize it, by merely cutting through the waxed paper and lifting the core out.

HOW TO USE

To operate the pickup, it should be placed under the strings of the musical instrument at a distance of not greater than 3/16-in. A flexible cord should be connected between the pickup terminals and the input jack of the amplifier. The pickup may be permanently secured to the instrument or it may be held in place by means of small rubber vacuum cups and metal brackets, as shown at Fig. 1L. The vacuum cups are made to hold various items on automobile windshields and may be obtained from most stores dealing in automobile supplies.

This pickup will work only with steel-stringed instruments. Of course, strings having a steel center but which have a wrapping of brass wire on the outside, also will operate the pickup.

The pickup operates on the principle that the metal strings vibrating across the magnetic field will cause changes in the lines of force cutting through the coils and set up a feeble current in the coil windings. *Since the current generated is very low, the amplifier used with the pickup should have a high gain and sufficient power output to cover the location in which it is to be used.*

AMPLIFIER

Experimenters who desire to build their own amplifier will find the one described below admirably suited not only to the electro pickup, but to many other applications of public address work as well.

Although the size of the chassis and the number of parts required have been kept to a minimum, the amplifier has a normal high quality output of 15 watts and a peak output of 22 watts, which is sufficient to cover an indoor gathering of 2,000 to 3,000 people. It has a gain of about 100 decibels, which in nontechnical language means that it is capable of amplifying, without the use of preamplifiers, a very weak signal such as put out by a crystal microphone. It may be used to amplify phonograph records simply by plugging in a high-impedance magnetic or crystal phonograph pickup into either of the input jacks provided.

The schematic wiring diagram of the amplifier is shown at Fig. 2. The lead from the input jack to the grid of the 6A6 tube

should be shielded, with the shield soldered to the chassis. No special precautions need be taken in wiring the amplifier other than to keep the grid and plate leads of the 6B5 tubes separated.

The 8-mf. filter condensers may be either dual or single sections, but if dual sections are used one of the sections should have 2 negative leads, rather than one common negative lead so that one of the leads may be connected to the cathode terminal of the 6A6 tube, instead of being grounded to the chassis as are the other negative leads.

It will be noted from the schematic diagram in Fig. 2 that the speaker field serves as a choke coil for the filter system. The speaker should have a field resistance of 1,000 to 1,500 ohms, and should have sufficient capacity to handle the full output of the amplifier. If it is desired to use a speaker with its own field supply, a 10-henry choke with a current rating of 150 milliamperes may be substituted for the speaker field. To reduce line noises and hum to a minimum, the speaker frame should be grounded to the chassis of the amplifier.

Both the speaker and amplifier may be mounted in a wood case provided with a handle, making a very compact unit for portable use. If it is desired to use one of the popular low-impedance (20-ohm) magnetic pickups, there is ample space for mounting its special input transformer on the chassis; or it may be mounted on the side of the cabinet, as shown in the back view of the amplifier. The list of parts for the amplifier follows:

LIST OF PARTS

- 1—Metal chassis, 6 x 12 x 2 ins.;
- 1—Power transformer, 750 V., center-tap, 6.3 V., 5 V.;
- 4—Cornell-Dubilier filter electrolytic condensers, 8 mf., 500 V.;
- 1—Cornell-Dubilier filter electrolytic condenser, 1 mf., 400 V.;
- 2—Cornell-Dubilier filter electrolytic condensers, 25 mf., 35 V.;
- 1—Cornell-Dubilier bypass paper condenser, 0.1-mf., 400 V.;
- 1—4-prong wafer socket;
- 2—6-prong wafer sockets;
- 1—7-prong wafer socket;
- 1—I.R.C. carbon resistor, 0.5-meg., 1 W.;
- 1—I.R.C. carbon resistor, 0.25-meg., 1 W.;
- 1—I.R.C. carbon resistor, 0.1-meg., 1 W.;
- 1—I.R.C. carbon resistor, 1 meg., 1 W.;
- 1—I.R.C. carbon resistor, 350 ohms, 1 W.;
- 1—I.R.C. carbon resistor, 150 ohms, 3 W.;
- 1—Centralab potentiometer (volume control), 0.25-meg., with line switch;
- 1—Push-push input transformer;
- 1—Filter choke, class "B" input, max D.C., 175 ma.;
- 1—Phone jacks, single circuit;
- 1—Sylvania type 5Z3 rectifier tube;
- 1—Sylvania type 6A6 tube;
- 2—Sylvania type 6B5 tubes;
- 1—Loudspeaker (and case) to match into 2—6B5's in class B.

Please Say That You Saw It in RADIO-CRAFT

FREE!

NEW EDITION OF THE
Greatest Catalog in
Radio
BIGGER THAN EVER!

—its brand new!

Completely revised and enlarged
Spring edition of the greatest catalog
in radio—out now. Send for your copy
at once. It's FREE! Tear off coupon
below and mail.

NEW
P.A.
with more
SELL!

With this issue Lafayette announces a great new line of sound systems for 1939. Here is revolutionary P.A.—new in smoother, finer performance, new in streamlined styling, new in operating economy. And for the first time, 3 distinct lines for you to choose from — Economy, Standard and DeLuxe. Truly Lafayette can offer this year a sound system for every purse and purpose. Complete range in all three lines from 5 to 70 watts. If you sell or rent sound systems, or if you've ever considered this highly profitable field, be sure to see what Lafayette has for '39. Send for FREE catalog today.

Hans—FOR YOU

there's a section packed solid with up-to-the-minute gear at down-to-earth prices. Plus the scoop of the year—Frank Lester's revolutionary new 5-10 converter. Tear off coupon and mail at once.

IN ADDITION—60 stunning new radio models, kits, parts, tubes. Mail the coupon. YOUR FREE COPY IS WAITING!

LAFAYETTE RADIO CORP.
AND WHOLESALE RADIO SERVICE

NEW YORK, N. Y. • CHICAGO, ILL. • ATLANTA, GA.
422 SIXTH AVENUE • 911 W. JACKSON BLVD. • 265 PRITCHETT ST.
BOSTON, MASS. • BIRMGH., N. Y. • NEWARK, N. J. • JAMAICA, L. I.

Rush New FREE Radio Catalog No. 76.

Name..... PLEASE PRINT

Address.....

City.....State.....

LAFAYETTE RADIO CORP.
Dept. 3D9—100 Sixth Ave., New York, N. Y.

PASTE COUPON ON PENNY POSTCARD

Readrite
RANGER

A. C. and D. C.
VOLT-OHM-
MILLIAMMETER

Only
\$12.00
net



Model 736

HANDY POCKET TESTERS

Model 736 A.C. and D.C. Pocket Tester Readings are: A.C. and D.C. Volts 0-15-150-750; D.C. at 1000 ohms per volt and A.C. at 400 ohms per volt; D.C. Milliamperes, 0-1½-15-150; Low Ohms, ½ to 1000; High Ohms, 0-100,000 at 1½ volts. External batteries may be used for higher resistance measurements. Has Triplett instrument. Molded case 3-1/16" x 5¼" x 2¼". All accessories \$12.00 included.

Model 737—for D.C. readings only. Complete with accessories. \$9.30

Model 735—same as Model 737 except operation is simplified by handy selector switch. Complete with accessories \$10.80

READRITE METER WORKS
416 COLLEGE DR., BLUFFTON, OHIO

SPRAGUE
ATOMS
"Mightiest Midgets of All"

NO OTHER MIDGET BRINGS YOU SO MANY FEATURES



More honest-to-goodness features—smaller sizes—at the lowest possible cost! That is the story of Sprague ATOMS, the amazing midget dry electrolytic condenser development that has rocked 'em and socked 'em from one end of the country to the other.

ATOMS are the smallest midgets on the market. They build up to higher surges than any similar units and have lower leakage and power factor. They're unconditionally guaranteed against blow-ups. They're made in more capacities, more voltages plus a complete line-up of dual capacity units with common negative leads. Self-supporting. You mount 'em like paper tubulars. You use 'em for any replacement where you want real efficiency, smallest size, lowest possible cost.

HANDY KITS
Sold singly or in handy kits of 6 or 12 condensers. Write for complete Sprague Condenser Catalog.

SPRAGUE
450 VOLTS
SPRAGUE
PRODUCTS CO.
North Adams, Mass.

RADIO TRADE DIGEST

TELEVISION CONTINUES ADVANCE—EXCEPT IN OPINION OF THE FCC

(Continued from page 609)

NBC HEAD SPEAKS

Conservative as is the statement of the Commission, still more so was an article by Major Lenox R. Lohr, NBC head, which appeared in a national magazine. Mr. Lohr stated that television programs, at first, would probably consist of about 2 hours per week.

Many think this would be very little entertainment to receive over a set costing some \$200 or more.

RCA & TELEVISION

David Sarnoff, President of RCA, pointed proudly to television progress when making his statement for the first of 1939. Mr. Sarnoff said, "During 1939 several new and important radio products will be introduced, including those related to television.

"Field tests in television conducted by RCA research engineers during the past 2½ years have resulted in development of the new art to a point where its introduction to the public in the areas served by television stations has become practicable. Therefore RCA will place television receiving sets on the market in April, 1939, coincident with the opening of the New York World's Fair.

"Thus, after many years of laboratory development, a modest beginning will be made to launch a new American industry. The RCA television transmitter in N.Y.C. will be operated in a limited service to the public by NBC. Programs telecast by television transmitters can be viewed on home receivers within a radius of approximately 40 to 50 miles of Radio City. The RCA is prepared to supply transmitters and equipment for television stations to those who may desire to pioneer in this new art. (Italics ours.—Ed.)

"One of the features of the RCA exhibits at both the New York and San Francisco expositions will be daily demonstrations of television. Radio facsimile and other important services of the immediate future also will be shown, together with exhibits of every phase of the present-day radio industry."

NBC & TELEVISION

Advances in television claimed by NBC include a mobile transmitter; the development of an antenna for radiating the frequencies needed for 441-line images.

HOSPITAL TELEVISION

According to American Television Corp., a New York hospital is installing one of their systems, so that student medics may witness operations. This is to be done on an experimental basis.

ZWORYKIN GETS PATENT

In December, 1938, Dr. Vladimir K. Zworykin was finally granted a basic patent on electronic television for which he had applied in December, 1923. Now he will have the privilege of defending it.

RETAILERS STOCKING UP

Despite the fact that television was not yet on the air, numerous retailers in the N.Y. metropolitan area put in Du Mont television receivers for demonstration and as a public attraction, according to the mfr.

BRUNO READING FACSY KIT

Its adv. agents, the Reiss Adv. Co., announce that Bruno Labs., N.Y.C., are preparing a bigger merchandising campaign for '39. Bruno will add a facsimile kit to its line of mikes, pickups & turntables.

DEMONSTRATIONS ON COAST

The Hollywood Television Society has been putting on demonstrations every Tuesday night. It has also put out a manual for experimenters located within range of W6XAO; it describes construction of a 15-tube receiver.

RTD EDITOR FOUNDS FUND FOR INDIGENT BROADCASTERS

(Continued from page 609)

ing Co., Columbia Broadcasting System, Mutual Broadcasting System and the National Association of Broadcasters. In the letter, Eichberg pledged 5% of his gross income from future royalties of his recent book, RADIO STARS OF TODAY, to the fund, and suggested that the networks and members of the association devote 1/100 of 1% of their net revenues to the same purpose, the fund to be administered by representatives of the 3 chains and the Association.

Interest was expressed by Neville Miller, Pres. of NAB, and Wayne L. Randall, representing NBC, though no definite commitments were made. No replies were received from A. J. McCosker, Pres. of MBS, or William S. Paley, Pres. of CBS. Eichberg plans to follow the matter up. He said, "It's the first time I ever tried to give anything away—and found no takers!"

SARNOFF SUMS UP

(Continued from page 612)

year-end finds the many services of radio in the fields of communications, broadcasting and manufacturing enjoying a high degree of public acceptance and confidence."

After commenting on NBC's advances, he added, "The RCA automatic distress alarm for ships, developed by the Radiomarine Corporation and now installed on a thousand American vessels, again demonstrated its value in making sea travel safer. S O S calls were picked up by 249 ships, many of which might not have received the signal had they not been equipped with the automatic alarm.

"RCA Manufacturing Company also has made marked progress during the year, not only in the marketing of broadcasting equipment to stations and sets for homes, but also in the development of related radio lines. Public demand for recording of popular and classical music continued its unbroken 7-year upswing. Simplified and improved sound reinforcing equipment has extended the application of sound to schools, business offices, homes and for outdoor use. The RCA Photophone sound-on-film recording method, increasingly in use in motion picture studios, has tended to raise the standard of sound reproduction in theatres throughout the country."

Please Say That You Saw It in RADIO-CRAFT

RADIO TRADE DIGEST

THE RSA MONTHLY BUGLE

(Continued from page 610)

their expenditures and put over a nice advertising campaign, over the RSA name, in one of the New York City evening newspapers.

Charles W. Fox has been elected to the presidency of the St. Paul (Minn.) Chapter. Also elected to office at the same time were Paul Davis, Vice-President, and Noel J. Granger, Secretary-Treasurer.

An open forum has been started. Questions offered for discussion are handled without the identity of the questioner being known.

The Ohio Valley Chapter is off to a flying start. Walter Stephanovich is the new treasurer; Paul Wright, Vice-President; Leonard Roberts, Jr., Secretary; Dick Harris, President. During the present year Chapter meetings will be held in the Maccabee's Hall.

Two new members are Bill Carter and L. V. Williamson. A. C. (Clarky) Clark has been advanced from honorary to regular membership.

P. A. Boyd, National Union Radio Corp., and former Station Relations Manager for Westinghouse, spoke at a recent meeting. At the unanimous request of the boys he remained after the close of the session to recount additional experiments which he had conducted at KDKA.

Names of 14 new Servicemen who applied for membership in the Washington Chapter last November have been referred to the membership committee.

The applicants are J. E. Abel; Herman Cohn; Ira P. Denning; Alvin P. Hines; W. B. Jones; Herbert A. Lewis; Webster A. Lovell; D. B. McLaughlin; A. L. Nichols; Norman T. Pirkey; Frank Russ; William L. Smith; Harold F. Winterburn; and Russell G. Wright. All applicants without member sponsorship must pass an examination to prove their fitness as radiomen.

W. B. Jones and George W. Cook were appointed to the membership committee; Jesse Channel was named chairman of the public relations committee and H. Strickland a member of the same committee.

The entertainment committee as now constituted consists of: Gordon C. Howard, Chairman; and Messrs. Franklin Kral and Herman Cohn.

Additional chapters of RSA will soon be operative in St. Joseph, Mo.; Scranton, Pa.; Ft. Wayne, Ind.; Springfield, Ill.; and Williamsport, Pa., home of the Central Pennsylvania Chapter; and Allentown, Pa.

Television in Chicago

The outstanding event of the month at the Chicago Chapter was a **Television Lecture** by Walter Kenworth of RCA Institutes.

This was the first lecture of its kind ever to be given in Chicago, and one of the first in America, at least as far as Servicemen are concerned.

Parallel to these proceedings, there was a meeting of the Women's Auxiliary which aims to promote such events and doings, as will contribute most to the uplift of the social status of the Chapter.

The annual election retained Ray Mason as President and Robert L. Storey as Secretary. Harold Cunningham was elected Vice-President and O. S. Dawson, Treasurer.

Chairman Cummings of the Danville Chapter at a regular meeting was presented with a brand new gavel made from an old radio set! Messrs. Goth and Welch handled the presentation ceremony just as well as they handled a discussion on resonance and alignment earlier in the evening.

There is considerable controversy there over the advent of television and Robert Keeling, appointed a committee of one to investigate, reported at the last meeting of the year on December 30.

His conclusion, concurred-in by those present, was that Servicemen should constantly be on the alert for the new developments of this new industry, Television, in spite of the fact that

it was believed it would not reach Danville for some time to come.

Listing bad-credit customers at the beginning of each meeting seems to be meeting with widespread approval.

The Detroit Chapter began the new year with an open meeting, to which members of the Pontiac Chapter were invited. The guest lecturer, was A. G. Mohaupt, of the Radio Training Association, who discussed "Alignment Procedure under Dynamic Testing."

A proposal of the Houston, Texas, Chapter that members begin the systematic study of television receivers at future meetings is having serious consideration.

At a recent meeting it was generally agreed that television would be here "before we realized it," and, once it took hold of the public's fancy, it would spread as radio did in the early days of broadcasting. Television data from "Electronics", "Service" and "RCA Service News" was presented by T. F. Stephenson and Secretary Stone.

To facilitate study it was also suggested that a projector to project diagrams, etc., on a screen either be purchased or built. The matter is in the hands of a committee consisting of Messrs. Fagan, Stephenson and Stone.

The 1939 Board of Directors of the Lansing, Mich., Chapter of RSA includes Ed Bloom, L. W. Aubil, J. H. Howe and Max Huntton, all elected for the 2-year term. E. J. Budd, C. Kachelski, H. Carlisle and R. Bell will serve for 1 year.

The new By-laws of the Chapter were read at this meeting, and were found satisfactory with 1 minor exception.

RMA & THE PARTS SHOW

(Continued from page 610)

ventions next year at San Francisco and New York of the Institute of Radio Engineers. Such additional exhibits, except of technical scientific instruments, are regarded as an unnecessary and undesirable expense to exhibiting companies.

AN EDITORIAL

(Continued from page 611)

will soon be jeopardized even in part to make way for a new system, no matter how desirable the results achieved by that system may be. If the new system does come into use, sets will probably be adapted to switch from "amplitude" to "frequency" at a finger's flip.

Government regulation standardized radio. Those standards will not be abandoned overnight. You can continue to stock up on sets designed for amplitude modulation; those intended for frequency modulation won't be in demand just yet.

Shucks, man, the industry hasn't even gotten around to high-fidelity yet. Few stations are putting out more than 5,000 cycle modulation; still fewer more than 9,000. And hi-fi receivers took quite a beating when they made their debut about 4 years ago.

RTD is in favor of all progress in the art of broadcasting. But it can't see why some papers are trying to scare the day-lights out of the radio consumer, by making him think that apparatus bought now may soon be obsolete.

It won't be!

Please Say That You Saw It in RADIO-CRAFT

Verti-flex-
**A NEW ANTENNA
DESIGNED TO MAKE
EXTRA PROFITS
FOR RADIO MEN!**

HERE is the finest engineered antenna in America for amateur or broadcast receivers—absolutely self-supporting, requires no guy wires and can be mounted to vertical wall or flat roof. VERTI-FLEX is made of special aluminum alloy and the entire pole measures 34 feet—weighs 6 lbs. (less insulator), and is equipped with automatic dampener to prevent oscillation when wind velocity is high.

No Hazards in VERTI-FLEX

Mountings have been approved to meet all insurance requirements and all antenna supports are built for life-time construction. The initial cost is the only cost.

VERTI-FLEX

Makes Profitable Installation

Radio men everywhere find it extremely profitable to install VERTI-FLEX—on apartments, hotels or private home—wherever antenna equipment is needed. With special noise-rejection system, VERTI-FLEX can operate as many as twenty broadcast receivers. It is handy for demonstration of radio sets in stores or shops.

Write today for technical bulletin on VERTI-FLEX Antennas. It gives complete information on proper installation of these ultra-modern antennas . . . how they operate . . . how they improve reception . . . how they make money for radio men.

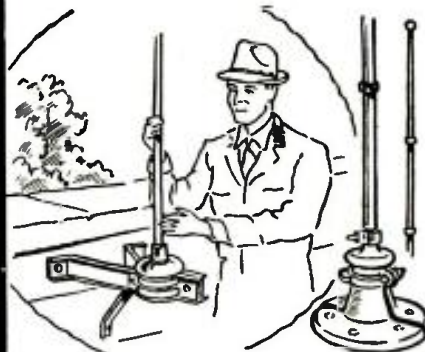

VERTI-FLEX Antennas are easily and quickly assembled for mounting on flat roof or side of wall. This modern antenna can be used as a straight antenna or as a noise-reducing antenna. With a proper installation, VERTI-FLEX will stand the life of any building.

ILLINOIS SEATING CORP.

2138 N. RACINE AVENUE

CHICAGO

Newest TECHNICAL BOOKS
 AT AMAZING **LOW PRICES**
 See Books Before You Pay!

NOW—the most sensational book offer in history! Unheard-of LOW PRICES for newest books on Radio, Electricity, Television, etc. Modern, Authoritative, Profusely illustrated, Crystal-clear. Many used as text books in schools. Ideal for home-study training.
 Order Now! Good times are on the way! The trained man has first chance at big-pay jobs. Prepare now through home study, at tremendous savings!

FREE GIFT
 if you send now!

PARTIAL LIST OF BOOKS

Cat. No.		
2	Radio Servicing Testers, 2 vol.	\$.98
4	Location of Faults in Radios	1.65
5	Short Course in mathematics, 2 vol.	1.00
6	Learnink to operate Slide Rule	.30
8	Short Course in Electricity and Radio, 2 vol.	1.45
9	Starting Electrical Repair Shop	.35
10	Fundamentals of Radio Theory	.75
11	How to Build a Home Laboratory Bench	.30
12	Home Experiments in Radio and Elec., 4 vol.	.70
14	How all types of Vacuum Tubes Work	.75
16	How to Read Circuit Diagrams	.35
18	Theory of Elec. Refrigeration	.35
19	Theory of Radio and P.A. Power Supply Units	.85
21	How Modern Television Works, 2 vol.	.65
22	How Photo Cells and Circuits Operate	.55

SENT FREE ON APPROVAL Mail the coupon for books wanted. Return them in 5 days without obligation—or send the very low price. Complete catalog free!

FREE GIFT "Electrical-Radio Dictionary" (value 40¢) given free with immediate cash order, \$2 or more. 12% discount and "Free Gift" book included with cash orders over \$3. 5-day return privilege still applies. Mail the coupon, TODAY!

ORDER far 5-days EXAMINATION

ELECTRONIC PUB. CO.
 Box 323-C4, Lincoln, Nebr.

Send books numbered below. Within 5 days I will send this price, or return the books postpaid.

(Order by catalog number)

NAME

ADDRESS

CITY

STATE

Check here if \$2 or more enclosed for Free Gift.

"DYNAMIC CONDUCTANCE" TUBE TESTER



Tests Octal and Single Ended Tubes

● Consolidated is proud to offer the new, up-to-the-minute, Model 9000 "Dynamic Conductance" Tube Tester. Engineered to give top performance. Built to take full advantage of greater accuracy afforded by dynamic mutual conductance circuit. Sells for only \$37.50.

See your jobber today!

CONSOLIDATED WIRE AND ASSOCIATED CORPORATIONS

524 S. Peoria St. Chicago, Ill.

RADIO TRADE DIGEST

FIRST LIST OF EXHIBITORS FOR 1939 CHICAGO PARTS SHOW

(Continued from page 611)

Companies who contracted for booths by Jan. 15th were due to take part in the Annual Drawing for Space Allotment in Chicago, January 25, such allotments being made in accordance with preferences indicated by each exhibitor.

Among the 1939 exhibitors will be:—
 Ampere Electronic Products, Inc.; American Radio Hdwe. Co., Inc.; Arcturus Radio Tube Company; Bud Radio, Inc.; Centralab, Inc.; Continental Carbon, Inc.; Cornell-Dubilier Electric Corp.; Clarostat Mfg. Co., Inc.; Hallicrafters, Inc.; Hygrade Sylvania Corp.; International Resistance Co.; Jefferson Electric Co.; Jensen Radio Mfg. Co.; P. R. Mallory & Co., Inc.; Meissner Mfg. Co.; Muter Co.; National Union Radio Corp.; Oxford-Tartak Radio Corp.; Presto Recording Corp.; Quam-Nichols Co.; Radio Mfg. Engineers, Inc.; Raytheon Production Corp.; Readrite Meter Works; Shure Brothers; Simpson Electric Co.; Solar Mfg. Corp.; Sprague Products Co.; Standard Transformer Corp.; Thordarson Electric Mfg. Co.; Triplett Electrical Instr. Co.; United Catalog Publishers, Inc.; Ward Products Corp.; Ward Leonard Electric Co.

PLAN AMPLIFIER SALES PROMOTION

(Continued from page 611)

member companies, have been made. The detailed program was approved by the RMA Board of Directors following presentation by Chairman J. McWilliams Stone of the Association's Amplifier and Sound Equipment Division. Performance characteristics of amplifiers will be checked at a testing laboratory selected by the Association. Following laboratory tests, the RMA "certificate of approval" will be attached. It is expected that the project will substantially promote sales of RMA-approved amplifiers and inform purchasers that such products of RMA member companies conform to specifications and advertising claims.

NEW ADDRESSES

(Continued from page 611)

WILLIAM MCFADDEN returns as Stan-cor's jobber rep. in Ind., Ky., & Ohio. Hq. will be at 256 E. Ostes St., Columbus, O. Bill also jobs Ohmmite. (See pix on pg. 611.) Bendix Radio Corp., a subsid. of Bendix Aviation Corp., is at 8-204 General Motors Bldg., Detroit, Mich. The new co. makes test equip't.

WALLACE B. SWANK, 610 Blaine Ave., Detroit, Mich., is representing mfrs. of service & amateurs' parts in Mich. (See picture on pg. 611.)

\$'s & No.'s Dept.

(Continued from page 612)

UPS & DOWNS in best billings for '38; NBC, up 7.3% to \$41,462,000; CBS, down 4.7% to \$27,345,000; MBS up 30.4% to \$2,920,000.

G-E BIZ OFF 34% in '38, to \$252,176,223.

EXPORT BIZ UP, though still below '37. Oct. was biggest mo. of '38, with \$2,332,854. —a ½-million gain over Sept. Breakdown

shows sales were 48,602 sets at \$1,118,231; 720,734 tubes at \$295,431; 35,219 speakers at \$61,921; \$513,743 worth of parts; \$343,528 worth of transmission equip't.

UP, \$ DOWN in Canada. Mfrs. there sold 35,518 sets worth \$2,900,000 in Oct., '38; 34,373 sets worth \$3,100,000 in same mo. of '37.

PERSONAL

(Continued from page 612)

buzzers, etc. The co. is Martin Research & Mfg. Corp., N. Y. C.

Neil C. Hurley, Jr., has been elected vice-pres. of the Independent Pneumatic Tool Co. He has been with the co. since 1932.

Dr. S. J. Begun, who came to the U. S. from Germany in '35 after impressive career in electro-acoustics, has joined the engineering staff of Brush Development Co.

JOHN J. MUCHER, head of Clarostat Mfg. Co., Brooklyn, N. Y., predicts a better parts biz in 1939—with a goodly portion of it derived from television receiver construction.

R. M. ALVORD, J. E. N. HUME, & A. S. MOODY, have all been appointed commercial vice-presidents of G-E.

FRANK WALKER adds the managership of the Victor & Bluebird Dept. to his duties as manager of RCA Victor's broadcast transcription division.

BROADCASTERS AND RMA UNITE ON GENERAL PROMOTION PROGRAM

(Continued from page 612)

plan, to develop a wider audience for broadcasters, more interest in radio, and stimulate sales and servicing. Selection of media for the general promotion program, preparation of pamphlets, sales aids, etc., will be developed.

The RMA Board of Directors also arranged for submission to the Federal Communications Commission of additional engineering and other data regarding television transmission standards, recently proposed to the Commission by RMA, and suggesting future public hearings on the technical standards.

The 1939 program for the fifteenth annual RMA convention at Chicago next June also was approved by the RMA Board of Directors. The Association's convention will be held at the Stevens Hotel, June 13-14, and the National Radio Parts Show, June 14-17.

SNOOPS & SCOOPS

(Continued from page 612)

Denmark will install the equip't in the new Copenhagen station . . . From Philco:—a new line of refrigerators is coming; Pres. L. E. Gubb says prosperity will return in 1939 unless war gets here first; R. F. Herr says schools & students will be a "best market"; Ford dealers won't handle Philco sets; & 2 new auto antennas are coming . . . Rumor says Amplifier Co. of Amer. will enter the service equip't field with special instruments for P.A. work—and we

RADIO TRADE DIGEST

believe it! . . . Another tid-bit, by our car-to-the-ground experts, is that Rudy Vallee will hit the air waves with Hammond's new "Novachord" (163-tube electronic music instrument described elsewhere in this issue of "R.C.") . . . That new group, Television Technicians, Inc., is contacting mfrs. for contracts on installation & service in N. Y. C. area.

OFF THE PRESS

(Continued from page 612)

8 pp. Circuits, data on apparatus, special offers, etc.
CHARACTERISTICS CHART. Arcturus Radio Tube Co. Data on 179 tube types, including replacement for 300 "ballast" types.
WE'VE MOVED! Aerovox Corp., New Bedford, Mass. 4 pp. Describes & pictures new plant—6 blocks long.
OSCILLATOR WOBBLATOR. Triumph Mfg. Co., Chicago, Ill. 2 pp. Circuit, pictures, description & price of Model 830.
1939 AERIAL CATALOG. Charles Avnet Co., N. Y. C. Home & auto antennas. Includes new noise-reduction masts to replace doublets.
1938-39 BULLETIN. Beck School for Radio, Minneapolis, Minn. 12 pp. Description of courses in announcing, acting, writing, production, selling time, engineering, etc. 15 courses are offered.

Weston Pointer Gives Plans for Prize Service Bench

Latest issue of Weston Pointer contains complete plans and specifications for build-

ing a radio service bench identical to the one awarded as first prize in the recent contest of the Weston Electrical Instrument Corp., Newark, N. J. Because of the great number of requests for these plans, the entire inside spread is given over to specifications for 2 (alternate) benches. Designed for use with Weston Models 772, 773 and 776, the plans provide an easy and inexpensive method of building a practical service bench—by submitting the plans to a local lumber dealer, the Serviceman can obtain all the necessary materials cut to the correct size, ready for assembly.

HARBORD SEES GAINS

In a year-end statement Major General James G. Harbord chairman of the board of RCA, said, "If one fact has emerged from the welter of terror and brutality which has submerged vast portions of the world during the past year, it is that Americans are lucky to be Americans . . . We are slowly but very surely working out our own salvation in a changing and turbulent world, and eventually, with strong and wise leadership, we shall arrive at a point where most of us will be content.

"Perhaps that happy day is not in the calendar of 1939, but undoubtedly the coming year will bring us closer to it. It may be that our progress will be rapid; but even if it is not, the impatient among us may console themselves by looking east and west beyond our borders and reflecting that things in America aren't so bad, after all."

HOW THE BEAM-A-SCOPE WORKS!

(Continued from page 605)

in which the vertical threads are metallic. All the vertical threads make contact with the top disc, but only 1 makes contact with the bottom disc. In this way there are no closed conducting circuits parallel to the loop, so that the Q of the loop is not damaged and the magnetic pick-up of signals is still possible.

Ordinarily the sensitivity of a loop would be small, but in the case of the beam-a-scope the sensitivity of a normal indoor antenna is retained, because the loop is tuned and has a high "Q". Since the loop size is determined in the design of the receiver, the condenser which tunes it can be ganged (and remain so indefinitely) with the condensers of the R.F. and oscillator circuits.

Besides the noise reduction obtainable with a beam-a-scope, there is also the additional very practical advantage that no external antenna or ground connection is required.

Good noise-reducing doublet antennas on the market today operate by means of directivity and elimination of ground noise pick-up in a manner somewhat similar to the beam-a-scope. Compared with these antennas, the beam-a-scope claims the advantage of the elimination of electrostatic induction field pick-up, and the convenience of the absence of external antenna and ground connections. No noise-reduction properties are claimed for the beam-a-scope on the shortwave bands.

Let us now consider a few practical points. In order to put a signal into a beam-a-scope for alignment purposes, it is convenient to attach a small loop to the terminals of a signal generator, and pick up a signal in the loop by induction from this. Beam-a-scopes are not amenable to the use of dummy antennas.

In a geographical region where the signal strength of usable stations is low and

(Continued on page 631)

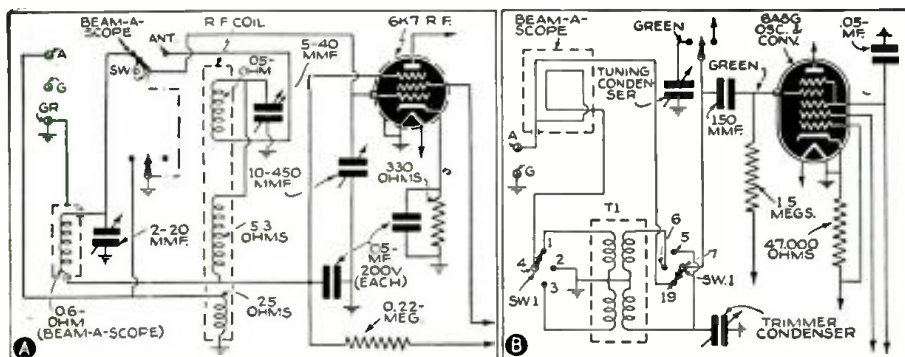

Fig. 2. Sometimes the Beam-a-scope (loop) can be grounded; more often, it can't. At A, you see how in the G.E. Radioforte model G-95 only the Faraday shield is grounded; and at B, how in the G.E. model G-99 set not only are the shield and the loop grounded (through Sw.1, or Sw.1 and T1, as the case may be), but also, an external antenna may be connected-in at a tap on the loop.

MORE ABOUT TELEVISION

... Sylvania 5-inch cathode-ray picture tube

SERVICEMEN— here's the Sylvania television tube for that larger-sized receiver you plan to build. Due to its larger size (5" screen), its advantages include both a bigger image and sharper definition. Sylvania is keeping abreast of the rapid developments in television art, and you, too, will want to play your part in its advance.

In cathode-ray tubes as in audio receiver tubes—you can count on Sylvania for high quality. Write today to Hygrade Sylvania Corporation, Emporium, Pa., for further technical data on this new tube.

SYLVANIA

SET-TESTED RADIO TUBES

Please Say That You Saw It in RADIO-CRAFT

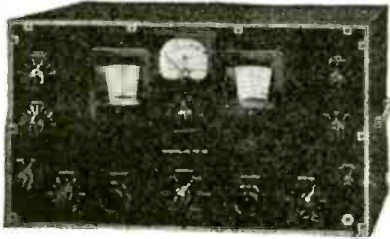

A Smashing Success!

THE NEW "HQ-120" is the talk of radio. Hams and fans everywhere are amazed over the remarkable results obtained with this outstanding receiver. Its extreme sensitivity is enabling users to tune in stations from all over the world with excellent volume and clarity. The new variable band width crystal filter can be adjusted to eliminate practically all adjacent channel interference caused by heterodynes and splash-over. Because this new crystal filter works as well on phone as on C.W., amateurs and short wave listeners alike are experiencing new thrills in DX'ing. Many other outstanding features are described in a 16-page illustrated booklet available on request.

MAIL COUPON!

HAMMARLUND MFG. CO., INC.
424-438 W. 33 St., N.Y. City RC-4

Please send 16-page booklet.

Name

Address

City State



HAMMARLUND

Canadian Office: 41 West Ave. No., Hamilton, Ontario

FREE!

Our new Catalog describing over thirty-two books in the "How to Make More Money" field has just come off the press. This catalog describes each book in detail. It enables you to select one or more books which will meet your requirements in an attempt to improve yourself financially.

Many of the books in the NATIONAL PLANS INSTITUTE catalog tell you how to start a spare- or full-time business of your own.

Write today for your FREE copy of the "NPI" Book Catalog—address a one-cent postcard to Dept. RC-439—and mail it today.

NATIONAL PLANS INSTITUTE
246-R FIFTH AVENUE, NEW YORK, N. Y.

NEW CATALOG 1939 AMPLIFIERS

Featuring amazingly low prices; Free Trial Offer; 5-Year Guarantee. Write for Catalog No. 3911.

AMPLIFIER CO. of AMERICA
17 WEST 20th STREET NEW YORK, N. Y.

ANNOUNCING THE "NOVACHORD"

(Continued from page 589)

of sound within the range determined by the setting of the panel volume switch. In addition there are 3 sustaining pedals. The two on either side of the Swell pedal, being interconnected, enable the player to use either foot to sustain notes played over the whole range of the keyboard. The sustaining pedal on the extreme left of the group has the same action as the other two but is effective only on the lower-half of the keyboard.

HOW TO PLAY IT

If the controls at the left of the Novachord are set to produce the same harmonics which piano strings produce, and those at the right are arranged to give the same percussive "envelope," the instrument will produce tones similar to those of the ordinary piano.

If the left-hand controls are set to produce the harmonics of the violin, and the right-hand controls to produce a sustained tone, an effect of strings is produced with no change in the playing technique!

Similarly, other musical instruments—the twang of the Hawaiian guitar, the soft, sweet notes of the clavichord and harpsichord, the brassy blare of the trumpet, or the mellow tones of the French horn—can be faithfully simulated.

Its inventor however does not consider it an imitative instrument in the sense that it would be substituted generally for any of the instruments whose voices (characteristic sounds) it can produce. It is his belief

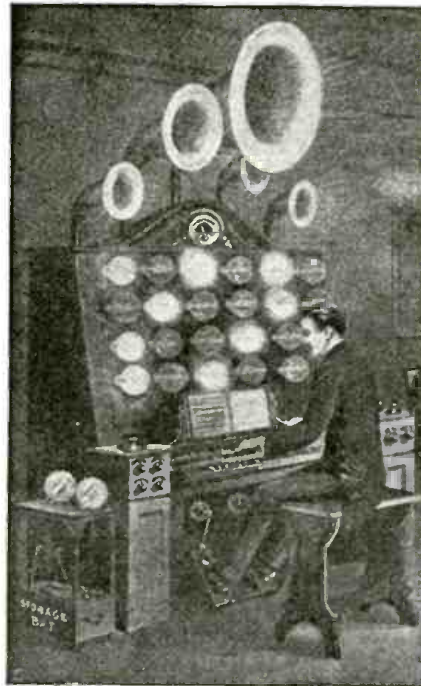

THE AUDION PIANO

Many readers of *Radio-Craft* are old-timers to whom mention of Mr. Gernsback's old magazine, *The Electrical Experimenter*, will recall the article, "Audion Bulbs as Producers of Pure Musical Tones," by Dr. Lee de Forest, in the December, 1915, issue. It is from this 2-page article *Radio-Craft* reproduces the illustration above; we quote the original caption: "The Audion Piano may entertain us in the near future with music purer than that obtainable with any instrument now available. Also it will imitate faithfully any orchestral piece."

It took nearly 25 years, but at last the radio art seems to have caught up with the clairvoyant abilities exhibited by the man who put the grid in the vacuum tube (and thus made modern radio possible). For in 1915, Dr. de Forest had produced in his lab., "the music of the lamps."

Size of box: 12 1/2" x 8 1/2"

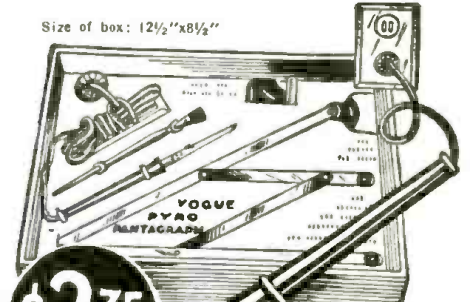

\$2.75

Shipping Wt. 3 lbs.

VOGUE Pyro Pantagraph

With this PYRO PANTAGRAPH turn leisure time into profitable hours. Make money a novel, easy way—"Burn Your Way to Extra Dollars with Pyro Pantagraph."

This electrical outfit is especially designed for burning designs permanently on Leather, Wood, Cork, Gourds, Bakelite, etc. Simply plug the Pyro-electric pencil in any 110-volt AC or DC outlet and it is ready to be used. Plug and cord furnished as part of equipment.

By the use of a special Pantagraph included in the outfit, any design may be reproduced either in original, reduced or enlarged form.

Outfit consists of: one Pyro-electric Pencil; one Pantagraph; three hardwood Plaques; one bottle of Varnish; one Brush; one tracing tip and four-page instruction sheet.

Outfit will be forwarded by Express Collect if not sufficient postage included with your order.

WELLWORTH TRADING COMPANY

558 W. WASHINGTON BLVD., Dept. RC-439, Chicago, Ill.

Radio Men Find This Book Handy

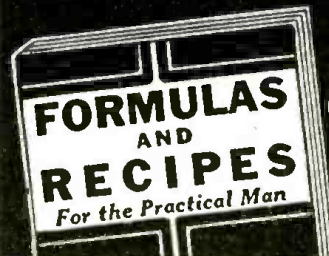

50¢ POSTPAID

Here is the Contents of the Book

1. Adhesives; Glues, Cements, Gums, Mucilages, Lubricants.
2. Cleansing; Stain Removers, Palm Removers, Bleaches, Cleaning Fluids.
3. Metal Craft; Coloring, Oxidizing, Plating, Repainting, Welding, Polishes, Alloys, Solders, Amalgams.
4. Paints; Colors, Stains, Varnishes, Enamels, Luminous Paint, Washable Paint; Paint-Removing, Waterproofing, Fireproofing.
5. Glass-Working; Cutting, Drilling, Boring, Bonding, Blowing, Etching, Engraving, Frosting, Silversing, etc.
6. Wood-craft; Fillers, Fireproofing, Acid-proofing, Waterproofing, Furniture Polishes, Finishes, etc.
7. Inks; Recipes, Erasers, Ink Stain Removers, Special Inks, Colored, Indelible, Sympathetic, Invisible, Hectograph.
8. Photography; Developers, Emulsions, Fixers, Sensitizing, Toning, Printing, Photographic Paper, Blueprint Paper.
9. Antidotes for Poisons, Remedies for Burns and Scalds, Disinfectants, First-Aid in Accidents, Emergency Remedies, Home Remedies.
10. Preparation, Manipulation, Handling, Mixing, Measuring, Weighing, Filtering, Straining Solutions; List of Technical Substances; Emulsifying; Use of Hydrometer. Use of Thermometer; Tables of Weights and Measures. Decimal Systems, Useful Tables.

TECHNIFAX, Division RC-439

560 W. Washington Blvd., Chicago, Illinois

TECHNIFAX, Division RC-439
560 W. Washington Blvd., Chicago, Illinois

Gentlemen: Enclosed please find 50c (check, money order, coin or unused U.S. stamps accepted) for which send me POSTAGE PREPAID. One copy of FORMULAS AND RECIPES for the Practical Man.

Name

Address

City State

Please Say That You Saw It in RADIO-CRAFT

it brings to music entirely new possibilities which will be developed for varied orchestral effects and for greater diversification and interest in home entertainment.

The music from the tone generator is amplified by conventional means and is heard through loudspeakers. The amplifying and speaking units are contained within the instrument, but for large installations where an unusual volume of sound is required, additional speaking equipment to any desired extent can be connected to the Novachord.

The Novachord is entirely self-contained and can be installed anywhere taking up less room than a grand piano. It is ready for use immediately after being plugged into any electric light socket. Its only elements of replacement are its tubes which, because of the small current they carry, have an estimated life of many years. All are of standard make purchasable anywhere.

Radio-Craft urges wide-awake Servicemen to canvass their territory for prospective customers for electronic musical instruments. The larger units, such as the organs and pianos, in addition to sales and service afford an opportunity for increased income through the charge for installation.

The older, Hammond Organ, Servicemen will recall contains only 2 tubes in the console, and 7 tubes in the associated "tone cabinet"; almost any desired, additional number of tone cabinets may be added.

It is interesting to note that Dr. Lee de Forest described an electronic organ, using individual tubes for each note, many years before the advent of broadcasting as we know it today. The December, 1915, issue of *The Electrical Experimenter* magazine contained Dr. de Forest's illustrated article on this instrument.

HOW THE BEAM-A-SCOPE WORKS!

(Continued from page 629)

the noise level is also low, it may be desirable to use an external antenna. In some receivers using a beam-a-scope there is a completely separate antenna circuit to be used in this case (see Fig. 2A); while in others the external antenna connection is tapped into the beam-a-scope (see Fig. 2B), thus using the beam-a-scope as an autotransformer. By this means the expense of a separate antenna transformer is avoided.

This article has been prepared from data supplied by courtesy of General Electric Co.

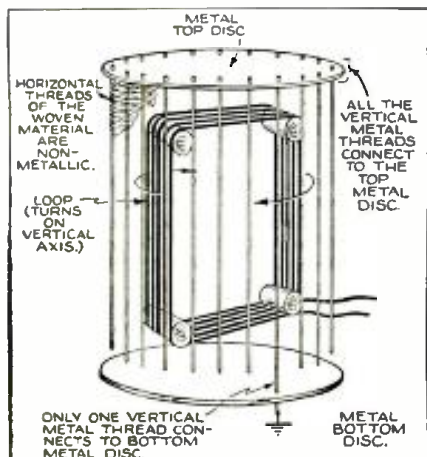

Here's an exaggerated illustration of the beam-a-scope, in principle. Actually, not 20 (as shown here) vertical metallic threads but a great number comprise the warp of the "cloth" cylinder that envelops the beam-a-scope's loop; the wool is composed of non-metallic horizontal threads.

THE LATEST RADIO EQUIPMENT

(Continued from page 607)

HIGH-GAIN 8-W. AMPLIFIER (1739) (Thordarson Electric Mfg. Co.)

THIS 4-tube beam power amplifier features individual control of mike or phono pickup for complete mixing. It supplies 6 W. for field excitation and has a convenient method of selecting output impedances. The amplifier is supplied in either an attractive metal screen cover or in a handy portable combination speaker and carrying case. The speaker case is of the bass reflex type (unusual with small portable amplifiers).

STAND-OFF INSULATORS (1740) (Hammarlund Mfg. Co., Inc.)

MADE of pure isolantite this new line of insulators is said to be remarkably free from breakage and chipping and thereby to withstand considerable abuse. Special consideration has been given to the terminal and other hardware. The tips (both plain and jack type) are made of heavy machine brass cadmium plated. Terminal lugs are unusually large and are thick metal, strong enough to support various pieces of apparatus. These lugs are of approximately the same diameter as the main body of the insulator. The bases, constructed for 2-hole mounting, may be removed if desired so that the insulators may be mounted directly to any panel or baseboard. For the latter type of mounting cork washers are furnished.

These new insulators are available in a variety of lengths from 3/4-in. to 3 1/2 ins.

BINAURAL AMPLIFIER (1741) (The David Bogen Co., Inc.)

A NEW 70-W. type DX70 binaural amplifier is available for use where auditory perspective and other types of operation require the simultaneous use of two independent audio channels.

Exclusive features are electronic tone correction, twin 35-W. output channels, 4 microphone and 2 phonograph inputs. Provision for 2-channel remote control with Bogen wireless or wired R.C. unit. Harmonic content is less than 4 per cent. With the dual circuit, which is incorporated in the design, auditory perspective or the effect of "moving sound" is created. Finished in black crackle, chromium trimmed.

NEW MICROPHONES (1742) (The Webster [Chicago] Company)

THESE 2 microphones feature improvements in both performance and appearance. Model 1236 is a diaphragm-type crystal microphone, especially adapted to high-quality P.A. work. The high-capacity torsion-drive crystal is moisture-sealed. Reproduction range is from 40 to 10,000 cycles. Output level -52 db. Case is finished in gun-metal grey.

The new dynamic microphone utilizes a moving coil mounted on a dural diaphragm. The frequency response is rated at from 50 to 9,000 cycles. The output level is -56 db. Assembly includes a balanced quadropi type winding transformer to eliminate stray electromagnetic pick-up. It is made in two types, model 1245 being high impedance and model 1245A low impedance (200 ohms). The manufacturer claims very low internal noise level and freedom from atmospheric or climatic effects. Assembly is contained in highly polished case of gun-metal grey.

Please Say That You Saw It in RADIO-CRAFT

● Triplett is the leading manufacturer of volt-ohm-milliammeters, combining 2% precision accuracy with economical prices.



The Tilting Twin Meter MAKES THIS VOLT-OHM-MILLIAMMETER RADIO'S No. 1 All Around Tester

Exclusive Triplett Features:

- Resistance Readings to 3 Megohms
- Separate AC and DC Instruments in Tilting Twin Case, Accuracy of Each 2%
- Selector Switch With Contact Error—Less Than 1/2% on M.A.

Considering its usefulness, flexibility and economical price, Triplett Model 1200-A, with its two separate meters is a natural choice for Radio's No. 1 all-around Tester. Every service dealer should own either the 1200-A or the adaptation of this model for special purposes as listed below.

Readings: D.C. Volts—0-10-50-250-500-1000 Volts at 2000 ohms per volt; 1-10-50-250 M.A.; low ohms, backup circuit, 1/2 to 500; 1500 ohms, 1/2 and 3 megohms. A.C. 0-10-50-250-500-1000 Volts.

OTHER MODELS

Model 1200-B . . . same as 1200-A but with DC movement and copper oxide rectifier for AC readings. DEALER NET . . . \$29.33

Model 1200-C . . . same as 1200-A but with 5000 ohms per volt DC. DEALER NET . . . \$26.83

Model 1200-E . . . same as 1200-A but with 25,000 ohms per volt DC. DEALER NET . . . \$31.17

Model 666 . . . Popular Pocket Size Volt-Ohm-Milliammeter. DEALER NET . . . \$14.00



THE TRIPLETT ELECTRICAL INSTRUMENT CO.
164 Harmon Ave., Bluffton, Ohio

Please send me more information 1200-A; 1200-B; 1200-C; 1200-E; 666.

Name

Address

City State

MR. SERVICEMAN

Make the Most of Your Time in '39!

MAIL THIS COUPON!

RADIO SERVICEMEN OF AMERICA, INC.
304 S. Dearborn St., Chicago, Ill.

Gentlemen:
I hereby make application for membership in the Radio Servicemen of America.

Name

Mailing Address

City State

I am enclosing \$4.00 for Dues and Initiation.
(Does not include Local Chapter Dues where Local Chapters are organized.) RC-439

★ *Make progress this year by using your time to the best advantage. Tie-up with the only national independent servicemen's organization in the industry and enjoy its benefits! The RSA is cooperative—run by and for its members—uncontrolled by any outside interests. You elect your representatives—all responsible officers are bonded.*

Here's what RSA gives you: ★ Monthly Advanced Circuit Notes for Members each month. ★ Technical Help on Service Problems. ★ Access to its National Speakers' Bureau. ★ Advanced Service Courses to Members at slight cost. ★ A Monthly RSA Publication. ★ Annual Convention. ★ And many other benefits now being planned. Join up with your fellow serviceman and be "in." Send the Coupon Today!

National Yearly Dues . . . \$3.00
Initiation Fee \$1.00

Let's Grow Together in 1939

RADIO SERVICEMEN OF AMERICA, INC.

Joe Marty, Jr., Executive Secretary ★ 304 S. Dearborn Street, Chicago



THE RADIO MONTH IN REVIEW

(Continued from page 583)

Western Union last month demonstrated a facsimile system that apparently satisfies the requirements their "Telepix" (facsimile) system of about 13 years ago failed to meet.

The new process, an outgrowth of the former, employs a dry recording paper which records written matter by direct electrical action. This new carbon-bearing, fibrous conducting paper is as sensitive to electricity as photographic paper is sensitive to light, and makes it possible to receive *positive prints* which can be used for reproduction purposes. In other words, observers point out, it should be possible to write a telegram and to produce an exact facsimile of that telegram, just as it was written, at the destination office. This may serve the dual purposes of speeding the delivery of the telegram, and of insuring accuracy through elimination of additional handling (typing, telegraphing, transcribing). This system in any event may provide these and other facilities when it is placed in commercial service for publishers and advertisers, and others interested in the rapid transmission of pictorial matter; law-enforcement agencies, in particular, will find such a service valuable.

Said H. C. Vance, Manager of Facsimile Sales, RCA Mfg. Co., in an address before the Pennsy. Newspaper Publishers Assn. convention at Harrisburg, Pa., last month: "So far, color printing, as it is known in the graphic arts, is not possible with radio

facsimile processes." (How about it, Mr. W. G. H. Finch?—*Editor*)

MORE TELEVISION

DAVID SARNOFF, referred to by the *New York Post* as No. 1 man of American radio, delivered an important message upon the occasion of receiving the Poor Richard's Club Gold Medal award of achievement at Philadelphia last month.

His message "Television Has Arrived" was conveyed (appropriately enough) by means of television. Sarnoff appeared, head and shoulders, on a screen like that used in the movies, 5 times natural size. He spoke into a radio transmitter several rooms away from the banquet hall, before a television projecting machine which carried his image to the banqueters. The president of RCA said in part, "In due time we shall see as well as hear through the air. And this will not be all. The promise of the future is greater than the glories of the past."

Radio-Craft has reported in past issues that London's television signals have been picked up at Riverhead, L. I. This erratic phenomenon which gives the lie to the belief that ultra-short waves carry only as far as the eye can see has established a new record, according to reports last month, as the result of images having been seen on television receivers in Arizona.

Did you see "Television Is Here!," by Lenox R. Lohr, president of the National Broadcasting Company in the January 14

issue of *Liberty* last month? "Reading time 7 minutes, 25 seconds." Among other reiterations was the one that plans call for N.B.C. to present 2 hours of television programming each week when RCA's general telecasting starts next April while sound programs are presented for 18 hours each day.

An interesting abstract in the December 1938 issue of *Business Digest* was the article, "Advertising Possibilities of Television," from the article, "Television: 1939's New Medium," in the November issue of *Advertising and Selling*. According to author John Archer Carter, with booster stations television programs from New York could cover the entire East.

Commercial television is still several years away. C. W. Farrier, N.B.C. television coordinator, told a meeting of the Art Directors' Club of New York last month. He said, "It is not likely that advertisers generally will become interested in television as an advertising medium until there are perhaps 400,000 receivers in this area. Our immediate problem is therefore one of building up an audience for television. That will probably require several years of broadcasting. Until that time N.B.C. and any other broadcaster who enters the field will be operating a medium which has no income."

Said Mr. Farrier, ". . . there are only a few hundred video receivers in the New York area. . . ."

Please Say That You Saw It in RADIO-CRAFT

OPPORTUNITY AD-LETS

Advertisements in this section cost five cents a word for each insertion. Name, address and initials must be included at the above rate. Cash should accompany all classified advertisements unless placed by an accredited advertising agency. No advertisement for less than ten words accepted. Ten percent discount for six issues, twenty percent for twelve issues. Objectionable or misleading advertisements not accepted. Advertisements for May, 1939, issue must reach us not later than March 7th.

Radio-Craft • 99 Hudson St. • New York, N. Y.

AGENTS WANTED

300% PROFIT SELLING GOLD LEAF LETTERS FOR store windows; Free samples. Metallif Company, 451 North Clark, Chicago.

BOATS

POP POP BOAT—FUEL FURNISHED. RUNS IN water like speed boat—20c. Vincent Saltese, 130-28 11 Ave., Whitestone, New York.

BOOKS AND MAGAZINES

WE HAVE A FEW HUNDRED RADIO ENCYCLO- pedias, by S. Gernsback, second edition, originally sold at \$3.98. Book has 352 pages, weight 3 lbs., size 9 x 12 inches. Red morocco—keratol flexible binding. Send \$2.49 in stamps, cash or money order and book will be forwarded express collect. Technifax, 558 W. Washington Blvd., Chicago, Illinois.

CAMERAS & SUPPLIES

AMBERTINT 16MM. CAMERA FILM, \$1.85 FOR 100 feet, including machine processing. Daylight loading. Weston Eight. Nonhalation. Two rolls \$3.50. Order now. Hollywood Studios, Southgate, Calif.

GENERA FILM—ALL MOVIE CAMERAS. 100 FEET 8 mm. \$1.00; double, \$1.75; 16mm. \$1.37. Sample for stamp. Processing Powders, Outfits, Frounaders. Davenport, Iowa.

COINS AND STAMPS

STAMP COLLECTORS—INTRODUCTORY OFFERING— 103 stamps including scarce Bi-colored Diamond and Triangular shaped Commemoratives—10c. Approvals. Friendly Philatelists. Box No. 4428R, Philadelphia, Penna.

FREE! JUBILEES, CORONATIONS AND AIR MAILS. Postage and Packing 10c. National Parks Stamp Shop, Gloucester, Mass.

EDUCATIONAL COURSES

USED CORRESPONDENCE COURSES AND RADIO service manuals bought, sold, rented. State your wants. Free Nat. Educational Exchange, Box 87, Fort Payne, Alabama.

FOR INVENTORS

CASH FOR UNPATENTED IDEAS. STAMP APPRE- ciated. Mr. Ball, 8441-J Pleasant, Chicago.

MISCELLANEOUS

MEXICAN DIVORCES: NO PUBLICITY. AMERICAN attorneys. Box 1736, El Paso, Texas.

PYRO PANTAGRAPH—THIS ELECTRICAL OUTFIT burns designs permanently on leather, wood, cork, gourds, bakelite, etc. Simply plug pyro electric pencil into any 110 v. A.C. or D.C. line and it is ready to use. Reduce or enlarge any design with special pantagraph included. Complete kit and instructions, \$2.75. (Add postage for shipping 3 lbs.) Wellworth Trading Company, 360-R West Washington Street, Chicago, Illinois.

MONUMENTS & TOMBSTONES

GENUINE MARBLE, GRANITE, FREIGHT PAID. Catalog free, \$11 up. United States Marble & Granite Co. A-27, Oneco, Fla.

OFFICE SUPPLIES

ENVELOPES—1000—6 1/2" \$1.75; 1000—10 1/2" \$2.85; 100 sheets, carbon paper \$1.50; prepaid. "Everything for the office." Labahn, 609 Main, Evanston, Illinois.

RADIO MEN, ETC.—125—8 1/2"x11" BOND LETTER— heads and 125 envelopes—\$1.00; statements, billheads, 300—\$1.00. Bennecille, 907 West Roosevelt, Philadelphia, Penna.

RADIO

SPEAKER FIELD, MAGNETIC, RELAY AND SOLEN- oid coils made to specifications. Single or large lot orders. Also rewinding. Nothofer Winding Laboratories, P. O. Box 455, Trenton, New Jersey.

SOMETHING BRAND NEW—UNIVERSAL PLUG-IN- type thermocouple. Unit ready to mount. One Dollar. B. D. Heller, 2374 Webster Avenue, New York, N. Y.

FAN BELT DRIVE A.C. GENERATOR FOR AUTO P.A. \$5.00. J. Orzyan, Kenosha, Wisconsin.

WE BUY AND SELL USED RADIO TESTING EQUIP- ment. Time payments if desired. Harold Davis, Inc., Jackson, Miss.

SERVICEMEN: RADIO CARTOONS ENLIVEN AD- vertising. Boost business. Cut catalogue 10c. Radiolabs, Windsor, Canada.

ANY RADIO CIRCUIT DIAGRAM 25c. ORDER MEN- tioning manufacturer's name, model. Catalog free. Supreme Publications, 3727 West 13th, Chicago.

ATTENTION RADIO SERVICE MEN AND SET owners: Have your radio receiver troubles and problems diagnosed, and the correct remedy prescribed by a broadcast receiver consultant. 15 years experience on all makes. Write for details. Send no money. Paul V. Castner, Columbus, Indiana.

RECEIVERS

PLANS 18 RECORD-BREAKING CRYSTAL SETS, SW record 4250 miles, with "Radiobulletin" year, 25c. Laboratories, 7700-B East 14th, Oakland, California.

SONG POEM WRITERS

SONGWRITERS! MELODY FOR WORDS \$1.00. Littig, 215 Mason Theatre, Los Angeles, California.

COMPLETE STEP-BY-STEP DYNAMIC SERVICING

(Continued from page 599)

broad characteristics rather than fine detail. None are shown here, therefore, but reference is had instead to significant patterns already explained.

TRACING TROUBLE

If the tests of Section Two (Part II) have been made, it is highly unlikely that the hum observed is due to any defect in the power pack.

To analyze further, note whether the hum pattern is principally 60 cycle or 120 cycle. (Compare Fig. 2B with 2D, 2C with 2E, and 2F with 2G, in Part II.)

Disconnect the voice coil and replace with a resistor of approximately the same value. If the hum pattern drops markedly in amplitude, it indicates a defective or misconnected hum-bucking coil in the speaker.

If the speaker proves to be OK in the above respect, remove the 1st audio tube and note the hum from the output stage alone. By eliminating stages preceding the power tube and replacing suspected tubes the source of trouble is rapidly discovered.

HUM FROM THE DETECTOR CIRCUIT

Turn up the audio volume control and note if there is any marked increase in the amplitude of the hum pattern. This is unlikely with a diode detector, unless the tube is defective or leads associated with the detector and volume control are lying too close to filament or other A.C. circuits. With triode detectors, a defective "B+" bypass condenser is indicated.

MODULATION HUM

With the receiver completely aligned and working, connect the Signal Generator to the antenna and ground circuit through a suitable dummy antenna, and tune the receiver to the generator at any frequency in the broadcast band. Turn off the modulation and note the hum pattern across the speaker voice coil.

Repeat at other frequencies and various values of unmodulated signal, noting the hum pattern. If there is any marked increase in the amplitude of the pattern, look for poorly filtered "B"-supply to one of the radio frequency circuits, defective R.F. or I.F. tube (test particularly for heater to cathode leakage), or A.C. getting into the A.V.C. circuit in some manner.

The next installment, Part V will complete this series of articles.

This article has been prepared from data supplied by courtesy of the Clough-Brengle Co.

Articles In The April Issue Of RADIO & TELEVISION

What Is The Rhumbatron?

Television Course.

Diagram of "Frequency Modulated" Receiver for Armstrong Signals.

Build this All-Wave 8-Tube Receiver—Herman Yellin, W2AJL

A Universal Test Meter—Easy and Cheap to Build.

Accurate World "Short-Wave Station" List. Roster of "Newly Licensed" Hams.

Short Wave "Listening Tips"—Joe Miller. Getting Started in AMATEUR RADIO—C. W. Palmer, E.E.

THESE TUBES PAY FOR THE EQUIPMENT YOU NEED!



... with the ARCTURUS EQUIPMENT DEAL!

The Arcturus Equipment Deal brings you an almost unlimited variety of the newest store and shop equipment . . . practically FREE! It enables you to make your shop more efficient, absolutely up-to-the-minute . . . it actually gives you EXTRA PROFITS in the form of valuable equipment!

NEW EQUIPMENT . . . PRACTICALLY FREE!

You'll find the Arcturus Deal gives you more for your money than any other. Lower Down Payments. Low Tube Requirements. Immediate Delivery—and only Standard Prices for tubes!

Send for details, and your FREE copy of the ARCTURUS DEALER HELPS folder. See how simple it is to get new equipment—how your purchases of Arcturus Tubes actually pay for it—how Arcturus Cooperation helps you sell!

NEW TUBES . . . NEW PROFITS!

Arcturus recently introduced several new tube types . . . more are on the way! These, and the famous Arcturus GT "MIDGETS", will further increase the huge replacement market now open to Arcturus dealers. Cash in on it! "Go Arcturus!"

MAIL THE COUPON!

ARCTURUS

ARCTURUS RADIO TUBE CO., Newark, N. J. C-18
Without cost or obligation, send my copy of the ARCTURUS DEALER HELPS Folder and details of the ARCTURUS EQUIPMENT DEAL.

Name.....
Street.....
City.....State.....
 I am a dealer I am a serviceman. My
jobber is.....

For your convenience this coupon can be pasted on a penny postcard

Please Say That You Saw It in RADIO-CRAFT

QUALITY—VALUE—GUARANTEE!

WESTINGHOUSE POWER GENERATOR

Manufactured for U. S. Signal Corps

A. C. ELECTRICAL POWER
 from a Windmill, from available Waterpower, from your Automobile, from your Motorcycle, from your Bicycle, Footpedals or Handcrank (for transportable Radio Transmitters, Strong Floodlights, Advertising Signal, operate two generators in series to get 200 V. AC; obtain two phase and three phase AC, etc., etc.

There Are Over 25 Applications
 Some of which are:
 A.C. Dynamo Lighting from eight to ten 20 Watt 110 Volt lamps. Short Wave Transmitter supplying 110 Volts AC for operating "Ham" transmitter. Motor Generator, Public Address Systems. Electric Sirens on motor boats, yachts, etc. Camp Lighting. Short Wave artificial "fever" apparatus. Television. Pelton Waterwheel for lighting or other purposes. Airplane: for lighting strong search lights or electric signs. Laboratory work, etc., etc.
 1/4 to 1/2 H.P. needed to run generator.

Generator, as described, including BLUE-PRINT 22 x 28 in. and Four-Page 8 1/2 x 12 in. INSTRUCTION SHEETS **\$7.90**
 Send \$2.00 deposit balance C.O.D. Shipping weight 18 lbs.

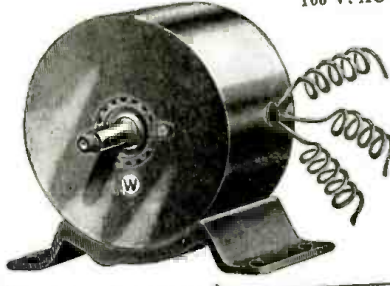

200 Watt, 100 V. AC

WESTINGHOUSE UNIVERSAL MOTOR

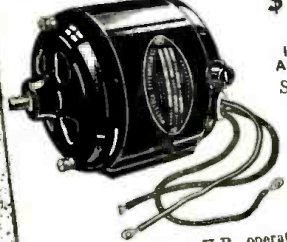

\$2.55
 110 Volts AC and DC
 Shipping Weight 8 lbs.

Specifications: 1/30 H.P. operates on either A.C. or D.C., 110 volts, 5000 R.P.M. Rheostat can be used to vary speed. Height 3 3/4", Length 3 3/4", Width 1 1/2". Shaft 1/4" diameter. Can be used to drive Sewing Machines, Models, Buffing Lathes, Polishing Head, Drills, Grindstones, etc., etc.

\$2.55
\$3.55
 MOTOR only
 MOTOR with Arbor and 3/4" Chuck.
 Add 25c for special packing and mailing anywhere in U. S. A.

G. E. PHONOGRAPH MOTOR

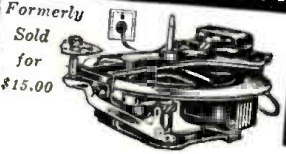

Formerly Sold for \$15.00

\$ ONLY 4.95

Variable speed induction type self-starting, 110 volt, 25 to 60 cycle, A.C. with speed control, plug and cord. Speed range from 5 to 200 R.P.M. Can be installed in place of old-fashioned, hand-wind, and a hundred other uses. These General Electric Motors have never been used and come four packed in original carton. G. E. Electric Phonograph motor as described (with out turntable) **\$4.95**
 Shipping Weight—12 lbs.

ALL OUR MERCHANDISE IS UNUSED AND SOLD ON A MONEY-BACK GUARANTEE

MICROPHONE AND RECEIVER

This Microphone and telephone headset outfit was built especially for the U. S. Navy Aviation Corps. The outfit to Government specifications. The outfit consists of a low-impedance carbon microphone (transmitter), securely fastened to a metal breastplate, and a set of heavy-duty, low-impedance earphones. A specially constructed switch on the back of the breastplate controls the microphone circuit. The earphones are U.S.N. Utah type, attached to adjustable headband. Twenty-eight feet of very heavy weather and waterproof conductor cable is furnished. Current storage battery is the most satisfactory current supply.

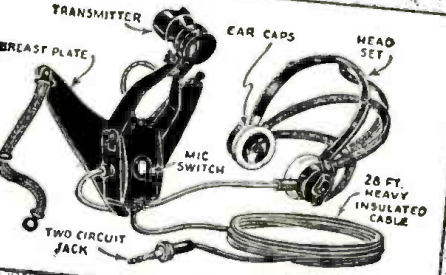

U. S. Navy Airplane-type Microphone and Receiver as described **\$4.96**
 Shipping Weight—9 lbs.

WELLWORTH TRADING CO.
 Dept. RC-439
 560 W. WASHINGTON BLVD., CHICAGO, ILL.

*** ORDER DIRECTLY FROM THIS ADVERTISEMENT ***
 WE SHIP 24 HOURS AFTER RECEIPT OF YOUR ORDER, BY EXPRESS, COLLECT OR PARCEL POST IF YOU INCLUDE SUFFICIENT POSTAGE.

A REVIEW— RADIO ABROAD IN 1938

(Continued from page 585)

the continued exploitation of existing technique. Outstanding, probably, is the emphasis laid on high over-all efficiency and the adoption in all new medium-wave transmitters of one or other of the high-efficiency modulation systems; for example, the use of high-power final stage class B modulating amplifiers, or low-power modulation with separate amplifiers for different components of the modulated wave, as in the Doherty circuit.

Outside the U.S.A., the first high-power Doherty type station is the 50 kw. Broadcasting Station of the Municipality of Buenos Aires, placed in service in the spring of 1938. This station was supplied through an associated company of the International Telephone & Telegraph Corp.

In Europe, medium-wave broadcasting is now established on the basis of a power of approximately 100 kw. for nearly 25% of all main stations. A number of such high-power stations are in course of construction, including a 100 kw. at Start Point, England, a 100 kw. in Sweden, two 100 kw. in Norway, a 120 kw. in Lithuania and a 120 kw. in Ankara, Turkey. Meeting a demand for still higher power involves a problem which will have to be settled at the forthcoming European Broadcasting Conference to be held in Switzerland in the spring of 1939. At present, by international agreement, no European station is normally entitled to use more than 120 kw.

Expansion of the broadcasting system of India has made good progress; there are now 8 shortwave regional stations in regular operation, rated at 5 kw. to 10 kw. In addition, a central station at Delhi radiates a news service and general interest items which are relayed through the regional stations.

The furnishing of a broadcasting system in India is attended with peculiar difficulties, not only because of the enormous territory to be covered and economic considerations, but also because of the problem of providing suitable program material for a country which has 12 distinct main languages and some 400 dialects. Since, in country districts, it is quite out of the question for each family to acquire its own receiver—even the cheapest receiver is beyond the means of the average native and, in any case, power supplies and battery charging equipments are very scarce—a scheme of "communal" village listening has been instituted. Under this system a village is supplied with a battery-operated loud-speaking receiver equipment, permanently tuned, and switched on at set hours by means of clock-switches. While the cost of such an equipment is borne by the local

BOOK REVIEW

SCIENTIFIC ENCYCLOPEDIA. Published by D. Van Nostrand Co., Inc. (1938). Size 7 1/4 x 10 1/2 ins., leatherette covers, 1,200 pages, 1,200 illustrations. Price \$10.00.

Association of Physics Teachers, it includes contributions from 200 top-flight physicists and 131 institutions. This should be sufficient recommendation for the authenticity.

Amplifiers, photoelectric cells, thermopiles, Geiger counters, electrometers, and many other pieces of technical apparatus and experiments that may be performed with them are described with sufficient minuteness to permit this book to be used as a school reference by physics teachers.

We quote as follows from the preface: "The Encyclopedia" covers the basic sciences of chemistry, physics, mineralogy, geology, botany, astronomy and mathematics; the applied sciences of navigation, aeronautics and medicine; and the 3 branches of engineering—civil, mechanical and electrical. In the treatment of these principal fields, many of the special sciences are included.

Consequently, any radio man who wants a technically accurate and detailed reference for any of the numerous topics covered by the "Scientific Encyclopedia" will find this book invaluable.

Over 10,000 terms of scientific interest are arranged alphabetically and an extensive system of cross-indexing has been developed to enable the reader to find all of the facts that bear directly on each included topic.

Prepared under the auspices of the American



A new Italian 4-station "sistema altoparlante per intercomunicazioni" or inter-office communicator, known as the Dufono, is shown above. Neat, eh?

Please Say That You Saw It in RADIO-CRAFT

administration, the actual supply and maintenance devolves on the broadcasting authorities themselves. The latter are thus in the unusual position of being directly responsible for both transmission and reception.

In England, recent developments in quartz crystal technique have resulted in the installation of independent crystal drives at British Broadcasting Corporation stations sharing a common wavelength. This system has replaced the distribution over telephone circuits of a driving tone generated by a tuning fork oscillator at a master station, and has resulted in improved reception from the synchronized transmitters. Each crystal oscillator has a frequency stability of the order of one part in 10^7 over a period of 24 hours. In order to maintain beats between the carrier waves of the respective stations at a very low frequency, inter-station frequency checks are made once or twice daily so that any necessary adjustment can be made.

The use of anti-fading aerials is now an accepted feature of all new medium-wave broadcasting stations. Such aerials may be of either the high mast type with no top-capacity loading, or of the type with a rather shorter mast combined with a capacity crown connected to the top of the mast through an inductive reactance. In all cases the height of the current loop above ground is about 0.25λ to 0.3λ . The actual height of the radiating element is not less than approximately 0.4λ , corresponding to an electrical length of 0.5λ to 0.57λ (λ -wavelength in meters).

Shortwave long-distance broadcasting continues to grow in importance, and practically every European country either has installed or is planning to install equipment for broadcasting to its nationals on other continents. The British Broadcasting Corporation is adding further high-power transmitters to its "Empire" station at Daventry, where 5 new aerials are to be erected, 2 to serve Central America, and the other 3 South America.

A central drive room is being built to house crystal drive equipment for the whole station. The output channels provided will enable any number of transmitters up to 12 to be fed independently with any required frequency, while provision is also being made for the synchronous operation of up to 4 transmitters from the same crystal.

The new Rome station, comprising two 100 kw. and one 50 kw. transmitters, is nearing completion.

The provision of local broadcasting services by countries situated in the tropical zones has hitherto been restricted by the lack of a suitable band of wavelengths. The medium waveband used so effectively in the temperate zones is useless in tropical regions owing to the high static noise level; while the short-wavelength broadcasting bands were primarily intended for long-distance working and suffer from skip-distance effect at a comparatively short radius from the transmitter. In view of these difficulties, the Cairo Telecommunication Conferences in 1938, made provision for local broadcasting in the tropical zones in the frequency bands between 2,300 kcs. to 2,500 kcs. (130.4 m.-120 m.), 3,300 kcs. to 3,500 kcs. (90.91 m.-85.71 m.), and 4,700 kcs. to 4,965 kcs. (62.89 m.-60.42 m.). By the use of these "intermediate" bands it is hoped to avoid both the high static level of the medium waves and the skip-distance limitation of the short waves. It is yet too early to estimate the effect of this change in promoting local broadcasting in tropical regions.

More for your Money

with the New

Universal Supertester



"MORE FOR YOUR MONEY" is often used by advertisers. But never has it hit closer than when we say "More for your money" with the new RCP Model 411 Universal Supertester. Check the features of this Supertester. You'll be quick to agree that this is the most complete tester at the price. Ideal for the serviceman—equivalent of 33 individual instruments. Just the job for television—ranges up to 5000 volts AC and DC; best all around tester for the ham—low and high AC and DC voltage, resistance and current ranges. Unequaled for the electrician and engineer—makes possible maximum number of measurements for plants, labs, etc.

- 5 stage, high AC-DC voltage range to 5000 volts.
- 3 stage, high AC-DC current range to 25 amps.
- Center of scale, on low ohmmeter range, only 5 ohms with each of first ten divisions measuring 0.1 ohm.
- 3 stage ohmmeter range up to 1,000,000 ohms.
- 3" sq. meter with movement of 200 microamperes or 5000 ohms per volt.
- DC microamps 0-200, DC milliamperes 0-500.
- db meter from -10 to 69 db in 4 stages.

Model 111 complete \$16.25 net. Model 411B same as Model 411 with additional provision for testing ballast tubes with octal bases—net—\$17.95. Other models at \$17.75 and \$19.45.

RADIO CITY Products Co.
88 PARK PLACE NEW YORK CITY

Sh! Confidential! Advance Engineering Bulletin!

Yessir! RCP engineers sure have been working overtime. We just heard that the new Model 504 analyst will be ready within the week. Here's a multiple circuit selector that gives maximum speed for analyzing symptoms at terminals. A few of the special features of this new job are:

- Local tube socket built into unit.
- Push button switches for both current and voltage.
- Two or more buttons can be pushed at same time without "shorting." Only job having this feature.
- Current and voltage can be checked at same time.
- Latest toggle latch plug and 7 adapters.

Model 504 complete with all adapters \$13.75
Model 504C same as 504 with 3" deep case \$14.95
Write for complete catalog.

Development in studio and speech input equipment was concentrated on providing mains operated equipment in a manner such that each unit is self-contained and furnished with its own power transformers, rectifier and smoothing equipment. The tendency is to rely on prime-mover equipment only in cases of mains failure.

In the acoustical treatment of studios, it might almost be said that two schools of thought have arisen. One holds that the acoustics of a studio are best controlled by geometrical factors, i.e., the shape and size of the room, and the provision of surfaces at suitable angles. The other school concentrates on the nature and absorbent power of the surfaces, rather than on the geometrical disposition. Excellent results have been obtained by both methods.

The new centralized studio system of the Belgian Institute National de Radiodiffusion at Brussels, supplied by the Bell Telephone Manufacturing Company, Antwerp, an associated company of the I. T. & T. group, was cut into service during 1938. This is a typical example of European practice, and provides no less than 17 separate studios, a number of which may participate simultaneously in the broadcasting of a play. This use of a number of studios for a single programme item may be contrasted with the general practice in the United States of employing, whenever possible, only one studio per item. From the technical viewpoint, the specialized use of studios is intimately bound up with the previously mentioned question of studio acoustics.

Broadcasting House, Glasgow, Scotland, was opened in November, with 10 studios, a control room and offices. The largest studio has a volume of 182,000 cu. ft. and will accommodate an orchestra of 100 players.

In Switzerland new studios are being put
(Continued on following page)

FREE TRIAL OFFER

NEW REMINGTON NOISELESS PORTABLE!
AS LITTLE AS



10¢ A DAY

Famous Remington Noiseless Portable that speaks in a whisper. Pay as little as 10¢ a day, guaranteed by the factory. Standard keyboard. Automatic ribbon reverse. Variable line spacer and all the conveniences of the finest portable ever built. PLUS the NOISELESS feature. Act now. Send coupon TODAY for details.

You don't RISK a Penny

We send you Remington Noiseless Portable for 10 days' free trial. If not satisfied, send it back. We pay all shipping charges.

Typing Course and Carrying Case

You will receive FREE a complete simplified home course in Touch Typing, a handsome sturdy carrying case if included. No obligation. Mail coupon for full details—NOW.

Remington Rand, Inc., Dept. 189-4,
465 Washington St., Buffalo, N. Y.
Tell me, without obligation, how to get a Free Trial of a new Remington Noiseless Portable, including Carrying Case and Free Typing Course for as little as 10¢ a day. Send Catalogue.

Name

Address

City State

EVERYTHING IN RADIO!

A COMPLETE SOURCE FOR YOUR RADIO NEEDS
Our immense stock of radio sets, parts and supplies enables you to purchase your entire needs on one order. You will find all your Nationally Known Favorites in this big booth which is FREE for the asking. Franchise every order is shipped the same day it is received.
WRITE FOR BIG NEW CATALOG

BURSTEIN-APPLEBEE CO.
1012-14 McGee St. - Kansas City, Mo.

Please Say That You Saw It in RADIO-CRAFT

CLEARANCE SALE!

Rockbottom Prices on Surplus, and Army and Navy Merchandise

When prices are low we buy! They're low now—**LOWER THAN THEY EVER WILL BE**—hence this sale. Most of the merchandise is new—never used; some of it reconditioned. 100% satisfaction on each transaction or your money refunded.

ORDER FROM THIS PAGE. Use the convenient coupon below. Be sure to include sufficient extra remittance for parcel post charges, else the order will be shipped express, charges collect. Any excess will be refunded. C.O.D. shipments require a 20% deposit. If full remittance accompanies order deduct 2% discount. Send money order—certified check—new U. S. stamps. No C.O.D. to foreign countries.

ORDER TODAY QUANTITIES LIMITED QUICK SHIPMENTS ASSURED

BEAUTIFUL KOLSTER RADIO



Brand New! Never been used before! Packed in their original crates. Beautiful walnut highboy cabinets designed for the one-time expensive Kolster battery receivers models 6D, 6G and 6H. In fact the R.F. tuners, never used, are still in them and go with them. Modern midge receiver chassis installed in one of these beautiful cabinets would certainly compare favorably along side a modern console radio. Three compartments are available: one for the R.F. tuner, one for the speaker and one for the batteries. What a cabinet for building a combination radio-phonograph or a TELEVISION RECEIVER. Plenty of room for a cathode ray tube. Measurements: 54" high, 27" wide, 18" deep. Shp. Wt. 164 lbs.

ITEM NO. 32 Your Price **\$4.95**

WESTINGHOUSE WATTHOUR METER

Completely overhauled and ready for immediate service. Designed for regular 110 volt, 60 cycle 2-wire A.C. circuit. Servicemen Use It in their shops to check current consumption of sets, soldering irons, etc. Keeps costs down. If dismantled, the parts alone would bring the price. The elaborate gear train could be used as a counter on machines of various kinds. Simple to install; 2 wires from the line and 2 wires to the load. Sturdily constructed in heavy metal case. Size: 8 1/2" high, 6 1/4" wide, 5" deep. overall. Shp. Wt. 14 lbs.



ITEM NO. 33 Your Price **\$4.50**

WESTINGHOUSE MODEL "WN" ELECTRIC HEATER

115-Volts, 1250-Watts



Radiant, clean Electrical heat—always at the flip of a switch. Use it in the bathroom, the living room, the den, anywhere. Leaves no dirt, no ashes, no soot. It is designed for permanent installation on any wall surface. Heating element is mounted on a special heater brick and protected by a cadmium-plated flame. Not fire hazard! A special baffle and back panel protect the wall. Sturdily constructed on a white-enamelled iron frame. Size: 15" high, 10" wide, 4 1/2" high overall. Shp. Wt. 23 lbs.

ITEM NO. 34 Your Price **\$5.49**

WESTON MODEL 562

A.C.-D.C. AMMETER

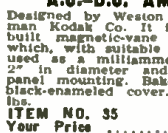

Designed by Weston for the Eastman Kodak Co. It is a precision-built magnetic-vane type ammeter which, with suitable shunts, can be used as a milliammeter too. It is 2" in diameter and designed for panel mounting. Bakelite base and black-enamelled cover. Shp. Wt. 2 lbs.

ITEM NO. 35 Your Price **\$1.25**

U.S. ENGINEER DEPT' MAGNETIC COMPASS

Designed to the high precision standards of the U.S. Government by Herachede. The extremely sensitive needle is mounted on a jeweled bearing and has a sliding weight on one side for maintaining an accurate balance. A metal scale around the periphery has a finely graduated scale permitting actual readings of all points of the compass. Students of electricity can use it as a galvanometer by wrapping a few turns of wire around it. Excellent for boy and Girl scouts, forest rangers, hikers, campers, trailer homes, etc. The entire instrument is recessed into a mahogany case. Shp. Wt. 2 lbs.

ITEM NO. 36 Your Price **\$2.65**

SPERRY GYROSCOPE LIQUID COMPASS

Made for U.S. Signal Corps; sensitive and accurate. Quick readings easily made from top; accurate readings of graduations through focusing magnifying lens on side of instrument. Complete with level sights and russet leather carrying case. Excellent for boats, boy scouts, campers, hikers, etc. A few turns of wire around its case makes it usable as a galvanometer. Shp. Wt. 3 lbs.



ITEM NO. 12 Your Price **\$1.85**

VARIABLE SPEED UNIVERSAL MOTOR

FOR 110 VOLTS, A.C. OR D.C.

Made for Dictaphone machines by American Gramophone Co. Used, but in excellent condition. Special lever control permits variable speeds up to 3000 r.p.m. 1/4" shaft extends from both sides of motor. Measures 7 1/2" x 3 1/4" diam. overall. Shp. Wt. 6 3/4 lbs.



ITEM NO. 11 Your Price **\$2.55**

FAMOUS VACUUM CLEANERS

Rebuilt Like New

Guaranteed for 6 Months

We give you new brushes, bags, handles, belts and other parts. The chassis is replated. All moving parts overhauled. Money back if not satisfied.

ELECTROLUX NO. 11—Radical design, cylinder type motor. Complete with all attachments. Foot control switch. Has 101 uses—cleaning upholstery, walls, draperies, curtains, mattresses, etc. Shp. Wt., 18 lbs. List Price, \$89.75.

ITEM NO. 30 Your Price **\$16.48**

HOOVER NO. 105—Motor driven brush. Foot control switch. Black enameled steel motor housing. 12-inch nozzle. Shp. Wt., 24 lbs. List price, \$63.50.

ITEM NO. 28 Your Price **\$13.95**



NEW FUEL PUMPS



Brown & Sharpe pumps. Brand new; never been used. Can be used for gasoline, oil, kerosene, and other fuels. Not good for water. Takes standard thread 1/4" input and output pipe. Has 1/4" drive shaft. Measures 4 x 3 3/4 x 3 1/4" diam. overall. Shp. Wt. 3 1/2 lbs.

ITEM NO. 24 Your Price **\$4.45**

PORTABLE TELEGRAPH AND BUZZER FIELD SETS



Made for military use by Western Electric. A wonderful buy if only for the parts it contains. Never been used. Good for code practicing, signaling, communications, etc. Contains 2-tone, high-frequency buzzer with platinum contacts, telegraph key, telephone switches, sarphone, condensers, transformers, chokes, etc. A \$50 value easily. Complete in wooden case with 41 grams and instructions. Shp. Wt. 12 lbs.

ITEM NO. 18 Your Price **\$5.45**

WE HAVE NO CATALOG. ORDER FROM THIS PAGE.

HUDSON SPECIALTIES • 40-R West B'way • N.Y.C.

IT'S EASY TO ORDER—CLIP COUPON—MAIL NOW

HUDSON SPECIALTIES CO., 40-R West Broadway, New York, N. Y. RC-439

I have circled below the numbers of the items I'm ordering. My full remittance of \$..... (include shipping charges) is enclosed.

OR my deposit of \$..... is enclosed (20% required), ship order C.O.D. for balance. (New U.S. stamps, check or money order accepted.)

Circle Item No. wanted: 11 12 16 24 28 30 32 33 34 35 36

Name Address

City State

Send remittance by check, stamps or money order; register letter if you send cash or stamps.

A REVIEW— RADIO ABROAD IN 1938

(Continued from preceding page)

into service at Zurich and Lugano employing negative feedback amplifiers of the type adopted by the I.N.R. in Brussels and by R.A.V.A.G. in Vienna; and the associated company of the I. T. & T. in Denmark recently received the order for complete equipment for the new broadcasting house in Copenhagen to be opened in 1940.

RADIO TUBES OR "VALVES"

While several new valve (tube) developments were achieved in 1938, the general tendency was to extend previous knowledge of constructional methods to produce a wider range of tubes, particularly in the case of tubes operating at ultra-high-frequencies and capable of providing considerable output at frequencies of the order of 150 megacycles. In general, advances in the field of frequencies greater than 150 mc. were not very extensive; Standard Telephones and Cables, associated company of the I. T. & T. in Great Britain, however, was successful in producing micromesh types of tubes yielding an output of 15 to 20 watts at a frequency of 240 mc. For operation with these tubes, the Standard Telephones and Cables valve laboratory developed a multiple-tube oscillator, and prospects of obtaining greater output at the higher frequencies are regarded as promising.

Investigations into the properties of water-cooled tubes for high frequencies continued. Several tubes, of a range of such tubes produced by Les Laboratoires, Le Materiel Telephonique, I. T. & T. associate in France, are being used in the Eiffel Tower Television Transmitter.

A number of manufacturers recently have shown interest in tubes of the cooled anode type in which water cooling has been replaced by forced air-blast cooling. Standard Telephones and Cables recently placed a 1 kw. radiation-cooled double-screen tube on the market. This tube is capable of dissipating 1 kw. on the anode and uses anode potentials up to 2,500 volts.

In wide-band transmission systems, a recent tendency is to employ a larger number of repeaters than previously; the tubes used in the repeaters are smaller and are tested to more exacting limits.

The advent of regular television services has increased the demand for high-vacuum cathode-ray tubes and, as a result, a variety of large-screen high-vacuum tubes has been produced. Interest recently has been centered round high-vacuum tubes with magnetic focusing, and this type of tube is now being produced by a number of firms. For vision amplifiers, special tubes have been developed and, it is interesting to note, the requirements for such tubes are very similar to those of tubes for wide-band transmission systems. The need for small cathode-ray tubes for general oscillographic and oscilloscopic purposes also has become apparent, and Standard Telephones & Cables has developed a small tube with a 3-inch screen, as well as a monitor tube for use in cathode-ray oscilloscope and triple-tube units.

Speech input equipment has developed along the lines of quality rather than power output, requiring tubes of high quality with respect to noise and constant characteristics. For the production of the necessary tubes with low noise, low microphonicity and close test limits, the introduction of special methods and equipment was required.

The broadcasting receiving tube has un-

Please Say That You Saw It in RADIO-CRAFT

FREE- REAL ELECTROPLATING OUTFIT



Now
You Can **ELECTROPLATE**
Easily with a **BRUSH**

SOMETHING new for radio men—something which gives you the opportunity to make additional profits—or to improve your type of service. Here's an **ELECTROPLATING KIT** amazingly simple to operate—you just Electroplate with a Brush!

NOT A TOY!

You can electroplate for profit, hundreds of things in the household—ashtrays, fixtures, water faucets, worn brackets, door knobs, musical instruments, jewelry and silverware and other articles. It's an indispensable piece of equipment to you for plating articles in hotels, apartments, office buildings, medical and dental offices, factories, schools, laboratories, etc. Exactly the same outfit (but larger) is used professionally by electricians, radio service men, automobile repair shops, etc. Requires one single dry cell 1½-volt battery to operate.

And for radio work, you can electroplate tarnished receiver parts, escutcheons, contacts, worn radio parts and accessories, and display chassis. Put this **REAL ELECTROPLATING KIT** to use immediately—make it the most useful article in your shop or laboratory. And, you can get it absolutely **FREE** (except for slight mailing cost).

Send your subscription today to **RADIO-CRAFT** for One Year (12 issues) and receive absolutely **FREE** this **REAL ELECTROPLATING KIT**. New subscribers are accepted or you may extend your present subscription another twelve months under this offer. Mail your remittance of \$2.50 (plus 10c for shipping charge on kit) to the publishers of **RADIO-CRAFT** (Canada and foreign \$2.85). You will promptly receive your **FREE, REAL ELECTROPLATING OUTFIT** by return mail. Use the coupon below to order your subscription.

RADIO-CRAFT

99 Hudson Street New York, N. Y.

RADIO-CRAFT RC-439

99 Hudson Street, New York, N. Y.

Gentlemen: Enclosed you will find my remittance of \$2.50 for which enter my subscription to **RADIO-CRAFT** for One Year (12 issues). Send me promptly my **FREE, REAL ELECTROPLATING OUTFIT** (Canada and foreign \$2.85). In U. S. add only 10c additional to cover shipping charges on kit.

New Subscriber Extend Present Subscription

Name

Address

City State

(Send remittance by check, money order or unused U. S. Postage stamps. Register letter if you send cash or stamps.)

dergone a number of modifications and a tendency exists to standardize on the American-type octal base tubes. Other developments worthy of note are the low-noise multi-electrode valves, and improved frequency changers. An interesting situation prevails in connection with all-metal tubes. In America, this type tube is going out of favor; recently, in Europe, a new type of "steel" tube was announced.

AVIATION RADIO

The use of radio as an aid to navigation is of paramount importance in the aviation field abroad, and progress during 1938 has been very marked.

Directional receivers are now fitted to almost all transport aircraft, sometimes in conjunction with discharge aerials for the suppression of rain and snow static. Frequently the directional loop aerials are mounted in streamlined casings; in some of the latest designs, the nose of the aeroplane is made of non-conducting material and, in these cases, it is possible to mount the loop system in the nose of the machine instead of externally and in a special casing. The study of different methods of using the properties of directional aerials to obtain bearings is still being vigorously pursued, and further improvements have been made in Europe in the R.C. 5 Standard-Busignies Automatic Radio Compass, the inherently higher accuracy and operating speed of which make it specially interesting. This radio compass is a development of Le Materiel Telephonique, associated company of the International Telephone & Telegraph Corp. in Paris.

The advantages of the medium-wave Adcock system of direction finding have long been known, but the commercialization of the system was slow, chiefly due to inherent difficulties in obtaining good balance between the component aerials and in avoiding pick-up in the horizontal connecting leads. That these difficulties have now been overcome is well illustrated by the experience of the French Air Ministry with a semi-portable Standard-Adcock equipment supplied by Le Materiel Telephonique, Paris. This equipment is mounted in a motor van and uses a pick-up system of insulated tubular metal mast aerials connected to the goniometer through screened aperiodic transformers and tubular transmission lines. The time required to complete the erection of a station is less than 6 hours, including the surveying necessary to ensure that the planes of the aerial pairs are accurately at right-angles to one another, that all the masts are accurately vertical, and that the corner masts are rigorously equidistant from the center point, together with careful laying of the earth mats and any necessary leveling of the site. The accuracy of bearings and freedom from night effect secured with this semi-portable equipment is fully equal to that obtained from a well-constructed permanent Standard-Adcock system.

For direction finding on medium wavelengths by ground stations, various forms of the Adcock system are today being widely applied. The impulse system of transmission, evolved as a means of overcoming night-error, appears to be losing favor. The use of Adcock direction finders, which depend on the vertically polarized component of the received signal, has reacted on the transmitting equipment used by aircraft. With the high air speeds now in use the weighted trailing aerial becomes practically horizontal and emits only a very small signal component with vertical polarization and it is, therefore, electrically preferable to employ a short fixed-aerial

(Continued on page 639)

LES Home Study Courses
at **Amazing Low Price**

RADIO
ENGINEERING and
TELEVISION
ELECTRICAL
ENGINEERING

Let Me Send You Complete Facts About My Low Price Courses!

\$25.00

BE AN EXPERT! Earn an expert's pay! Enjoy an expert's security! Prepare at home, at very low cost, for one of thousands of openings for trained men! "Armed with my L.E.S. diploma, I quickly landed a new position," writes F. Armatronk, Texas. "Have nice radio business, thanks to L.E.S.," says E. O. Kane, Detroit. "Promoted to Section Radio Chief, U. S. Army Air Corps. "Your L.E.S. course a large factor!" says C. Schauers, Cal.

RADIO & TELEVISION An exceptional course in radio, public address photo-electric work. Trains you to be super-service man, real vacuum tube technician. You'll be earning money fixing radio sets before you're half through. Crystal-clear. Television training included without extra charge.

ELECTRICAL Good jobs seek out expert Electrical Engineers! This modern simplified home-study course gives you a practical understanding of the wide electrical field. Everything clear, interesting, very understandable.

EXPERIMENTAL KITS FURNISHED Complete equipment to perform many radio and electrical experiments. Gives you the experience you need. Included.

FREE Send for free copies of School Catalogs, Student magazine, full details of Low Tuition, Deferred Payment Plan, Diploma, etc. Write TODAY!

LINCOLN ENGINEERING SCHOOL
Box 931-C4 Lincoln, Nebr.

MAIL for Free Book—Today

B. C. Burden, Chief Engineer,
LINCOLN ENGINEERING SCHOOL,
Box 931-C4, Lincoln, Nebr.

Please send me free copies of your school catalog, student magazine, full details and low prices.

NAME AGE

ADDRESS

CITY STATE

Have You Tried The N12 HN NOKOIL Speaker?

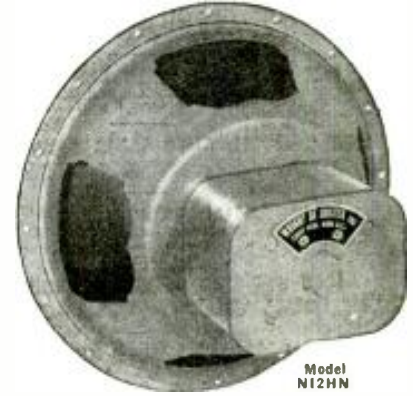

Model N12HN

- 116 oz. Magnet
- 20 Watt-Power Handling Capacity

This Speaker installed in the Metalex Horn is perfect for Church Chimes, Talking Towers and all type of outdoor installations.

List Price **\$29.00**

Write for Complete Information and Catalog.

WRIGHT-DECOSTER, Inc.

2251 UNIVERSITY AVE., ST. PAUL, MINN.

Export Dept.: M. Simons & Son Co., New York
Cable Address: "Simontrics"

Canadian Representatives:
Wm. F. Kelly Co., 1207 Bay St., Toronto, Ont.
Taylor & Pearson, Ltd., Edmonton, Alberta

Please Say That You Saw It in **RADIO-CRAFT**

For Better Servicing - - For Bigger Profits - - Use Gernsback Manuals and Books!

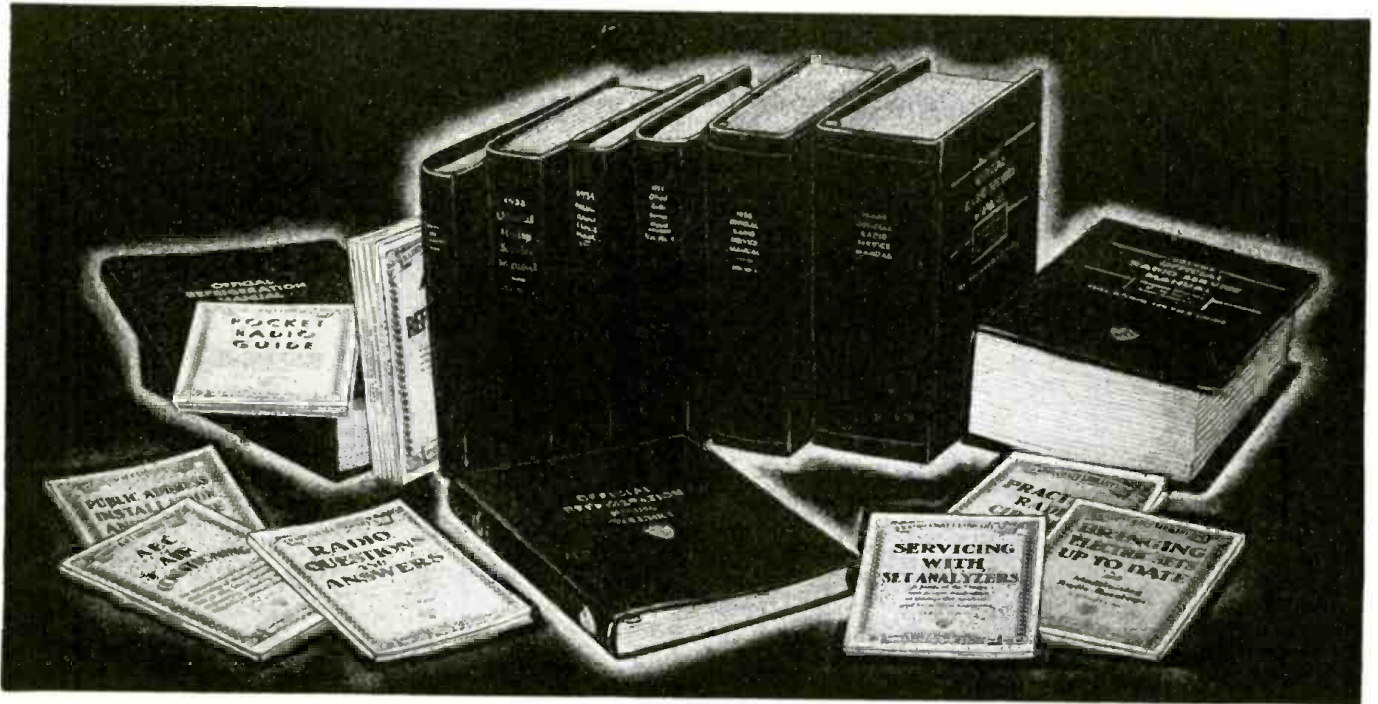

SINCE 1931 Servicemen have been buying more **GERNSBACK OFFICIAL RADIO SERVICE MANUALS** year after year. The authentic material, easily accessible diagrams and complete service data make them invaluable to dealers and radio Servicemen. *Without a Gernsback Service Manual at the repair job, there's time and profit lost.* Your service kit or laboratory is incomplete without *all* the **GERNSBACK OFFICIAL RADIO SERVICE MANUALS**. There are **GERNSBACK MANUALS** for servicing auto-radios, also refrigeration and air conditioning equipment.

VOLUME 7 OFFICIAL RADIO SERVICE MANUAL
Over 1,800 Pages • Over 3,000 Illustrations • Stiff, Leatherette, Looseleaf Covers • Size 9 x 12 inches • Net Weight 10 1/4 lbs. **\$10.00**

1936 OFFICIAL RADIO SERVICE MANUAL
Over 1,200 Pages • Over 2,500 Illustrations • Stiff, Leatherette, Looseleaf Covers • Size 9 x 12 inches • Net Weight 8 lbs. **\$7.00**

1935 OFFICIAL RADIO SERVICE MANUAL
Over 1,000 Pages • Over 3,000 Illustrations • Flexible, Leatherette, Looseleaf Covers • Size 9 x 12 inches • Net Weight 3 3/4 lbs. **\$7.00**

1935 OFFICIAL AUTO-RADIO SERVICE MANUAL
Over 240 Pages • Over 500 Illustrations • Flexible, Leatherette, Looseleaf Covers • Size 9 x 12 inches • Net Weight 1 3/4 lbs. **\$2.50**

1934 OFFICIAL RADIO SERVICE MANUAL
Over 400 Pages • Over 2,000 Illustrations • Flexible, Leatherette, Looseleaf Covers • Size 9 x 12 inches • Net Weight 2 1/4 lbs. **\$3.50**

1932 OFFICIAL RADIO SERVICE MANUAL
Over 1,000 Pages • Over 2,000 Illustrations • Flexible, Leatherette, Looseleaf Covers • Size 9 x 12 inches • Net Weight 4 1/2 lbs. **\$5.00**

OFFICIAL REFRIGERATION SERVICE MANUAL (Volume I)
Over 450 Pages • Over 1,200 Illustrations • Flexible, Leatherette, Looseleaf Covers • Size 9 x 12 inches • Net Weight 2 3/4 lbs. **\$5.00**

OFFICIAL REFRIGERATION SERVICE MANUAL (Volume II)
Over 352 Pages • Over 300 Illustrations • Flexible, Leatherette, Looseleaf Covers • Size 9 x 12 inches • Net Weight 1 1/4 lbs. **\$5.00**

OFFICIAL AIR CONDITIONING SERVICE MANUAL
Over 352 Pages • Over 900 Illustrations • Flexible, Leatherette, Looseleaf Covers • Size 9 x 12 inches • Net Weight 2 1/4 lbs. **\$5.00**

To order these famous Manuals, see or write to your jobber or favorite mail order house. If more convenient, mail coupon directly to publishers.

RADCRAFT PUBLICATIONS, Inc.
99 HUDSON STREET NEW YORK, N. Y.

Get into the swing of reading instructive, authoritative books on technical subjects—radio, air conditioning and refrigeration. It's the easiest, quickest and most inexpensive way to improve your knowledge on these topics. In this series, popularly known as the **RADIO-CRAFT LIBRARY SERIES**, are all the titles necessary to your personal advancement. Only by careful study of these enlightening books, can you gain adequate experience in fields of radio, air conditioning and refrigeration. Each book is uniform. The volumes measure 6 x 9 inches—contain 64 pages, and have stiff, flexible covers. **PRICE 50c PER BOOK.** All books are sent to you postpaid.

Here Are The Titles:

- | | |
|--|---|
| Book No. 2
MODERN VACUUM TUBES | Book No. 14
POCKET RADIO GUIDE |
| Book No. 3
THE SUPERHETERODYNE BOOK | Book No. 15
ABC OF REFRIGERATION |
| Book No. 6
BRINGING ELECTRIC SETS UP-TO-DATE | Book No. 16
PRACTICAL RADIO CIRCUITS |
| Book No. 9
AUTOMOBILE RADIO AND SERVICING | Book No. 17
SERVICING WITH SET ANALYZERS |
| Book No. 10
HOME RECORDING AND ALL ABOUT IT | Book No. 18
POINT-TO-POINT RESISTANCE ANALYSIS |
| Book No. 12
PUBLIC ADDRESS INSTALLATION AND SERVICE | Book No. 20
THE CATHODE-RAY OSCILLOSCOPE |
| Book No. 13
ABC OF AIR CONDITIONING | Book No. 21
BREAKING INTO RADIO SERVICING |
| | Book No. 22
NEW RADIO QUESTIONS AND ANSWERS |

EACH BOOK IN THIS SERIES—50c

RADCRAFT PUBLICATIONS, Inc., 99 HUDSON ST., NEW YORK, N. Y.
Gentlemen: Enclosed find my remittance of \$..... for which send me, **POSTPAID**, the Manuals or Books indicated below by a cross (x) in the panel.

() Volume 7 @ \$10.00 () 1936 Manual @ \$7.00 () 1935 Manual @ \$7.00
() 1935 Auto-Manual @ \$2.50 () 1934 Manual @ \$3.50 () 1932 Manual @ \$5.00
() Refrigeration Manual (Vol. I) @ \$5.00 () Refrigeration Manual (Vol. 2) @ \$5.00
() Air Conditioning Manual @ \$5.00

RADIO-CRAFT LIBRARY SERIES @ 50c EACH

Circle book numbers wanted: 2 3 6 9 10 12 13 14 15 16 17 18 20 21 22

Name Address

City State

(Send remittance in form of check or money order; register your letter if you send cash or unused U. S. Postage Stamps.)

RC-439

Please Say That You Saw It in RADIO-CRAFT

A REVIEW— RADIO ABROAD IN 1938

(Continued from page 637)

giving a larger proportion of vertical polarization, this preference being strongly reinforced by mechanical considerations. Since, however, the radiation efficiency on medium wavelengths of such fixed aeri- als is rather low, their adoption has been accompanied by a demand for higher transmitter power in order to maintain signal strength. This tendency to increased transmitter power is apparent as is also a tendency to confine operation to spot-wavelengths. Modern aircraft transmitters are thus considerably more complicated than those of a few years ago and, in the interest of safety, many of the larger transport planes carry a small emergency transmitter in addition to their main equipment.

The application of the Adcock system to short waves continues to be the subject of much study, particularly in connection with long-hop trans-oceanic flights. Whether complete reliance can be placed on such a system still remains to be established, and the increasing traffic on all air lines has forced the investigation of other methods.

Radio air navigation on the North American continent has long been based on the fixed AN course-beacon system, and is now further aided by the use of aircraft direction finders as an auxiliary to the course beacons. In Europe an extensive triangulation system of non-directional radio beacons has been laid out to facilitate navigation over the principal routes for aircraft equipped with direction finders or radio compasses. Trials are also being made with rotating beacons, but no definite conclusions have yet been reached as to the value of this innovation.

Probably the outstanding feature of aviation radio today is the rapidly developing application of the ultra-shortwave band due to its well known advantages for this class of service.

The first use of the ultra-shortwave band for aviation services was for instrument landing systems and now nearly all the principal airports in Europe are fitted with the Lorenz system of instrument approach developed by C. Lorenz, A. G., an associate in Germany of I. T. & T.

In the United States the development of a standardized instrument landing system is progressing rapidly under the new Civil Aeronautics Authority and the International Telephone Development Co., Inc., which is a subsidiary of I. T. & T. Corp.

In the United States there has been a distinct trend toward the utilization of higher frequencies for point-to-point navigation as a result of recent development by the Civil Aeronautics Authority and International Telephone Development Co. The marker beacon installations, used initially for providing fixes along the approach beacons, are finding universal application for procuring fixes along the AN systems in America and for marking obstructions. They have also been used in a modified form for the purpose of defining exactly the cone of silence over the AN beacon transmitters in view of the fact that the cone of silence produced by the beacon itself is a negative rather than a positive indication.

In Australia a similar type of equipment has been used for point-to-point navigation along lines similar to the AN beacon system; the advantage claimed is complete freedom from false courses.

The outcome of experiments extending through the end of 1936 and the year 1937, Les Laboratoires, Le Materiel Telephonique,

Paris, have developed an improved space track instrument landing system for aircraft. Three ultra-shortwave channels between 33 and 38 mc. are used; all transmitters are controlled by low-temperature-coefficient quartz plates and use selenium rectifiers. After a preliminary demonstration in February, 1938, before French officials, the new system was selected by Air France, the French Air Transport Company, for training their pilots in instrument landing. On December 2nd, a very successful demonstration was given of the qualities of the system, and of the training of Air France pilots before the experts of the International Air Traffic Association, an organization comprising representatives of all European air traffic companies.

Work is being done in both Europe and the United States to ascertain the coverage of low-power ultra-shortwave equipment for purposes of airport traffic control. In addition to freedom from interference from other stations, a great gain in signal-to-noise ratio is being found under conditions of snow and rain static. Allocations for nearly all aircraft services have now been made in the ultra-shortwave band, and it is certain that development of suitable apparatus for aerodromes and planes will proceed rapidly.

The utilization of ultra-shortwaves to the measurement in an aircraft of its height above ground represents an outstandingly interesting development. The ordinary altimeter does not read the height above the actual ground level but the height above a given datum line; moreover, this height is not read directly but in terms of changes of barometric pressure. Inasmuch as the latter is subject to additional variations depending on the prevailing atmospheric conditions it is necessary to apply corresponding corrections, the magnitude of which may alter, unknown to the pilot, during the course of a flight. An instrument with a response indicating directly the height above the actual ground should, therefore, be of great value. The acoustic depth sounding devices now fitted on many ships are of this nature, their response being proportional to the time taken by a signal emitted from the ship to return to the ship after reflection from the bed of the sea. Such devices are not readily applicable to aircraft, but ways are now being found of applying the same principle by using radio waves rather than acoustic waves. Since the velocity of radio waves is much greater than that of acoustic waves—186,000 miles/sec. as against 0.2-mile/sec.—the time interval is too short to be measurable with the required accuracy, and recourse is therefore had to the measurement of some change in the character of the signal proportional to the length of path.

"THE BEST THING WE COULD HAVE DONE . . ."

. . . comments one reader upon our announcement of the forthcoming big May issue—the ANNUAL CATALOG NUMBER. Besides the regular articles and features, this issue will contain a complete directory of "Who-Makes-What" in the radio industry. Further it will contain the master catalogs of many well-known manufacturers; and finally, will announce the important P.A. INSTALLATION CONTEST. Many additional pages will be added to the magazine—AT NO EXTRA COST TO YOU.

The New 1939 RADOLEK Profit Guide NOW!

Get your free copy!

EVERYTHING IN RADIO IN THIS BIG NEW 1939 Radolek Profit Guide.

Radolek has everything under one roof. When you order, you get just what you want promptly and economically. Over 25,000 Radio Servicemen and Dealers now depend upon Radolek Service. Send for your copy of this big book.

OVER 12,000 REPAIR PARTS. Parts to repair any radio receiver made. All leading brands. Every item guaranteed! And all at prices that **SAVE YOU MONEY!**

ALL TUBES. RCA, Sylvania, Raytheon, Philco, etc. Includes Kellogg, special Majestic types and transmitting tubes.

TEST INSTRUMENTS. The most complete line ever displayed in any catalog. Latest improved models that provide every conceivable test necessary for thorough radio receiver analysis.

COMPLETE PUBLIC ADDRESS DISPLAY. New 1939 model public address amplifiers with outputs from 10 to 100 watts. Complete P.A. Systems for permanent, Mobile and Portable installations. Attractively designed and priced for greater profits.

LATEST RADIO MODELS. The super values of 1939. New Phonoradio combinations. Automatic tuning sets. Strikingly beautiful cabinets. Also new "I-I-am" receivers and transmitters!

COMPLETE AUTO RADIO SECTION. Includes vibrator replacement guide, new auto aerials, custom panel control plates for all automobiles and new Delco Auto Sets.

3000 NEW ITEMS OVER PREVIOUS EDITION. New items to give you new ideas in conducting your business on a more profitable basis.

The RADOLEK Co.

601 W. Randolph, Chicago, Dept. C-28

Send the 1939 Radolek Radio Profit Guide FREE.

Name

Address

Service man? Dealer? Experimenter?

Please Say That You Saw It in RADIO-CRAFT



RESISTANCE ANALYZER and INDICATOR
FOR USE WHEREVER RESISTANCE MEASUREMENTS ARE MADE

An indispensable radio instrument for every ham, serviceman and experimenter. Fuse protected, fool-proof, guaranteed. Dozens of uses. Determines resistance values; estimates taps and values of controls; serves as voltmeter multiplier, rheostat or potentiometer; voltage divider; calibrated gain control or attenuator, etc., etc. Direct reading dial. Only 1 knob adjusts resistance from 0 to 1.0 megohm. Bakelite case 4 3/4" x 3 1/4". Three fuses. Interesting 16-page instruction manual supplied with each Analyzer.

Net Price (complete) . . . \$4.95



All Metal
11" long x
5 1/2" deep x
5 1/2" high

RADIO'S HANDIEST PARTS CABINET

This new All-Metal IRC RESIST-O-CABINET contains the first really balanced resistor assortment. Supplied complete with 59 famous IRC Resistors in practically every type and range commonly used in service work. You pay only the standard prices for the resistors. The cabinet is yours at not one cent of extra cost. The 59 resistors include popular ranges in 1/2- and 1-watt Insulated Metallized Resistors; also 10-watt fixed and adjustable wire wounds, the latter giving every range

from a few ohms up to 10,000 ohms. Cabinet contains four large drawers with seven compartments in each. Designed to stack solidly, one atop the other.

List Value of Resistors \$15.16
(The Cabinet is included)

NOTE: Resist-O-Cabinet not sold empty.

INTERNATIONAL RESISTANCE CO.
401 N. Broad St., Phila., Pa.



By the makers of
Insulated Metallized RESISTORS

STANDARD OF QUALITY EVERYWHERE

SERVICING QUESTIONS & ANSWERS

(Continued from page 608)

kc. are not cut in signal strength at all.

(A.) Trouble such as you describe with an Atwater Kent Model 711 has been traced upon different occasions to one of two failures.

Leakage on the wave-hand switch will produce an inoperative condition upon low frequencies. Employ a stiff-bristle brush (a toothbrush will do), and carbon tetrachloride to clean each section and segment of the switch.

Check and/or replace each series condenser in the oscillator circuit. Clean the broadcast band padder with carbon tetrachloride. An intermittent series condenser is usually the chief cause for this complaint.

FREQUENCY DRIFT—"CHOKING"

(125) H. L. Colyer, Freeman Spur, Illinois.

(Q. 1.) In a Clarion Model 360, when you are tuned, to say 700 kc. The set plays fine for awhile then it will start to distort. Retune to 710 or sometimes to 690 kc. and it is OK for 5 or 10 minutes; then you have to move back to 700 kc. for 2 or 3 minutes—then move again! It is like this all around the dial and *only* occurs at night. All resistors, condensers and tubes, and the volume control, have been tested by substitution. All voltages OK.

(A. 1.) Frequency drift in this model is usually caused by the I.F. trimmers. Check these components for faulty mica insulation or stripped adjustment screws. Remove the padder condenser in the oscillator circuit and bathe with carbon tetrachloride. Check for faulty mica insulation or unsoldered leads of the condenser.

(Q. 2.) In a Philco 640, it seems like the signal is choking or is interrupted in its passage, causing the speaker cone to pulsate very rapidly and violently. After set warms for 15 minutes or so it isn't so bad, just a small noise now and then like boiling water. The shadow meter also flutters when this takes place. Have substituted all condensers, tubes, and the volume control.

The screen-grid voltage is 10 volts high in the R.F., mixer and I.F. stages.

(A. 2.) The fact that the shadowgraph is affected by the condition described points to trouble in the R.F. portion of the receiver. We suggest replacement of the triple section electrolytic condenser, one section of which is the screen-grid bypass condenser. The manufacturer's part number is 30-2114 for this condenser. Check the 6A7 tube.

BOOK REVIEW

MAGNETISM, Physics in Industry, (1937). Published by The Institute of Physics, London. Size 6 x 9 1/2 ins., 47 illustrations, 102 pages. Price, \$1.00.

This little book contains a series of lectures delivered before the Manchester & District Branch of the Institute of Physics.

"Magnetism" is recommended to radio men who would like to have conveniently at hand a book to cover the ground work of modern magnetic theory.

Lecture headings follow: Magnetism and the Electron Theory of Metals; Electrical Sheet Steel; The Influence of the Properties of Available Magnetic Materials on Engineering Design; Magnetization Curves of Ferromagnetics; Permanent Magnets; X-ray Studies on Permanent Magnets of Iron, Nickel and Aluminum.

Index to advertisers

A	
Allied Radio Corporation.....	619
Amperite Corporation.....	622
Amplifier Co. of America.....	630
Arcturus Radio Tube Company.....	683
B	
The Brush Development Company.....	635
Burstein-Applebee Company.....	619
C	
Capitol Radio Engineering Inst.....	620
Central Radio Laboratories.....	620
Classified Section.....	633
Consolidated Wire & Assoc. Corps.....	628
Cornell-Dubilier Electric Corporation.....	618
Coyne Electrical School.....	579
D	
The Data Print Company.....	616
E	
Electronic Publishing Company.....	628
H	
Hammarlund Mfg. Company.....	630
Hudson Specialties Company.....	636
Hygrade Sylvania Corporation.....	629
I	
Illinois Condenser Company.....	623
Illinois Seating Corporation.....	627
International Resistance Co.....	640
K	
Kelsey Company.....	622
L	
Lafayette Radio Corp.....	625
Lancaster, Allwine & Rommel.....	622
Lincoln Engineering School.....	637
M	
Meissner Mfg. Company.....	Back Cover
Miles Reproducer Co., Inc.....	618
Modell's.....	622
N	
National Plans Institute.....	630
National Radio Institute.....	577
National Schools.....	621
National Union Radio Corp.....	622
O	
D. W. Onan & Sons.....	618
R	
Radio & Technical Publishing Co.....	616, 621
Radio City Products Company.....	635
Radio Servicemen of America, Inc.....	632
Radio Training Association.....	622
Radolek Company.....	639
RCA Institutes, Inc.....	624
RCA Manufacturing Co., Inc.....	Inside Front Cover
Readrite Meter Works.....	626
Remington Rand, Inc.....	635
S	
Service Instruments, Inc.....	617
Solar Manufacturing Co.....	619
Sprague Products Company.....	626
Sprayberry Academy of Radio.....	614
Superior Instruments Co.....	Inside Back Cover
Supreme Instruments Corp.....	621
T	
Technifax.....	630
Thor Radio Company, Inc.....	618
Triplet Elec. Instrument Co.....	631
The Turner Company.....	616
U	
United Radio Company.....	621
Universal Microphone Co., Ltd.....	624
W	
Wellworth Trading Company.....	634, 630
Wholesale Radio Service Co., Inc.....	625
Wright-DeCoster, Inc.....	637

(While every precaution is taken to insure accuracy, we cannot guarantee against the possibility of an occasional change or omission in the preparation of this index.)

SUPERIOR PRESENTS 5 INSTRUMENTS

from its NEW 1100 series!!!! Never before has Superior offered so much for so little! Always the Best Buy in the Instrument Field, Superior in this new 1100 series gives you even more value! We have incorporated many refinements, many new features . . . all proven to be sound and practical. We urge you to read the descriptions below carefully; see how these instruments fit your needs. Buy direct from manufacturer and save 50%.

ments, many new features . . . all proven to be sound and practical. We urge you to read the descriptions below carefully; see how these instruments fit your needs. Buy direct from manufacturer and save 50%.

SUPERIOR INSTRUMENTS ARE GUARANTEED FOR ONE YEAR

THE NEW MODEL 1110-S A.C. - D.C. VOLT OHM MILLIAMMETER

A Midget in Size—A Giant in Performance

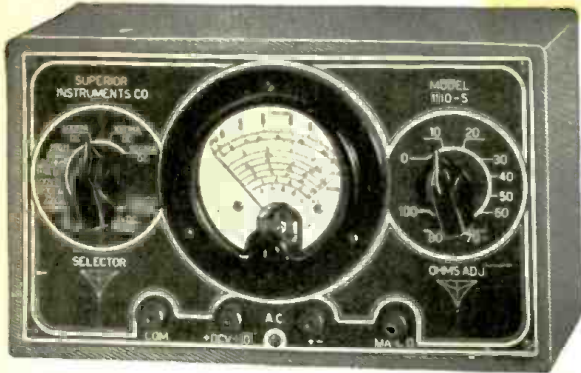

Features modern 0-1 d'Arsonval type meter, precision resistors, neat etched panel housed in new striped fabricoid case.

SPECIFICATIONS:

0-1.5 volts D.C.	0-500 ohms	500-500,000 ohms.	0-15 volts A.C.
0-15 volts D.C.	0-1 ma. D.C.		0-40 volts A.C.
0-25 volts D.C.	0-10 ma. D.C.		0-75 volts A.C.
0-75 volts D.C.	0-100 ma. D.C.		0-200 volts A.C.
0-500 volts D.C.	0-500 ma. D.C.		0-1200 volts A.C.

Model 1110-S supplied complete with batteries, test leads and instructions. Size: 8½" x 5" x 3¼". Shipping weight, 5½ pounds. Our net price.

\$7⁸⁵

THE NEW MODEL 1130-S

Signal Generator with Audio Frequencies



SPECIFICATIONS:

1. Combination R.F. and Audio Signal Generator. R.F. 100 kc. to 100 Mc. A.F.—100-7,500 cycles. All Direct reading, all by front panel switching.
2. R.F. and A.F. output independently obtainable alone or with A.F. (any frequency) modulating R.F.
3. Accuracy is within 1% on I.F. and Broadcast bands; 2% on higher frequencies.
4. Audio frequencies in 5 bands: 100, 300, 1000, 5000, and 7500 cycles.
5. Glant airplane full vision, direct-reading dial.
6. Condenser and other leakages tested to 100 megohms.
7. All services on 90-130 volts A.C. or D.C. (any frequency).

Model 1130-S comes complete with tubes, test leads, carrying handle, instructions. Size 12" x 9" x 6½". Shipping weight 15 pounds. Our net price.

\$11⁸⁵

THE NEW MODEL 1150-S SUPER-ALLMETER

Featuring the New Sloping Panel



A genuine achievement! For accurate and rapid measurements. Note the following features: A.C. and D.C. Volts, A.C. and D.C. currents, Resistance, Capacity, Inductance, Decibels, Watts.

SPECIFICATIONS:

- D.C. Voltage: 0-15, 0-150, 0-750 volts D.C.
- A.C. Voltage: 0-15, 0-150, 0-750 volts A.C.
- D.C. Current: 0-1, 0-15, 0-150, 0-750 ma. D.C.
- A.C. Current: 0-15, 0-150, 0-750 ma. A.C.
- 2 Resistance Ranges: 0-500 ohms, 500-3 megohms
- High and Low Capacity Scales: .0005 to 1 mfd. and .05 to 200 mfd.
- 3 Decibel Ranges: -10 to +19, -10 to +38, -10 to +53. Inductance: 1 to 700 Henries
- Watts: Based on 6 mw. at 0 D.B. in 500 ohms. .006000 to 600
- Utilizes new 4¼" square 0-1 d'Arsonval type meter with precision resistors housed in our newly devised sloping case for rapid and accurate servicing.
- Model 1150-S supplied complete with test leads, tabular charts and instructions. Size 10" x 7¼" x 4¾", shipping weight: 9 pounds. Our net price
- Model 1150-A Portable carrying cover 75c additional.

\$11⁸⁵

THE NEW MODEL 1180-S SET TESTER

A Complete Laboratory All in One Unit!

Featuring Our New Type Sloping Panel for Precise and Rapid Servicing



A complete testing laboratory all in one unit! Complete Superior models 1140-S and 1150-S. For specifications read the description of both these models herewith. Comes housed in sturdy, black case with sloping panel for rapid and simple measurements. Complete with test leads, tabular charts, instructions and tabular data for every known and receiving type tube, including many transmitting types. Size 11½" x 8¼" x 5". Shipping weight 18 pounds Our net price

\$17⁸⁵

Model 1180-A for Portable Cover, add 95c.

THE NEW MODEL 1140-S TUBE TESTER



A really modern tube tester conforming to all standards of good engineering practice. Utilizes a 3" d'Arsonval type meter with calibrated scale. Furnished in a sturdy black case with sloping panel for easy operation. Removable cover and carrying handle for either portable or counter use.

SPECIFICATIONS:

1. Tests all 4, 5, 6, 7, 7L, and octal base tubes, including diodes.
 2. Tests by the well-established emission method for tube quality, directly read on the GOOD? BAD scale of the meter.
 3. Affords separate neon test for leakage and shorts between elements.
 4. All services performed by the use of only five controls at maximum, and many tests do not require working all the controls.
 5. Supplied with instructions and reference table so that the filament voltage and emission measuring controls may be properly set for the enumerated long list of tubes, which includes all tubes commonly encountered in servicing.
 6. Works on 90-120 volts A.C. 60 cycle.
- Model 1140-S comes complete with instructions and tabular data for every known receiving type of tube as well as many transmitting types. Shipping weight 10 pounds, size 10" x 7¼" x 4¾". Our net price
- Model 1140-A with Portable Cover 75c additional

\$10⁸⁵

SUPERIOR INSTRUMENTS CO. 136 Liberty St., RC-439 NEW YORK, N. Y.

IT'S HERE AT LAST A PRACTICAL TELEVISION KIT!!



SOUND as well as VIDEO—
both in one unit!



The New Shock-proof design!



Meissner quality at a price any-
one can afford to pay!



Meissner is FIRST with practical
TELEVISION because Meissner
has put years of time in research
to be READY when REAL
TELEVISION arrived. It is
HERE NOW!



Get your name in NOW for the
first information!

Two models—one with 3-inch and one
with 5-inch tube!



The last word in modern TELEVISION!

WRITE TODAY FOR FULL DETAILS!

MAIL COUPON!

MEISSNER MFG. CO.
Mt. Carmel, Ill., Dept. R.C.-4
Please rush me information on
TELEVISION KITS!!

Name.....
Address.....
City..... State.....

Meissner
DEPT. R.C.-4 MT. CARMEL, ILL.

"A FAMOUS NAME FOR TWO DECADES"